

GRAPHIC OPERATION TERMINAL

# GOT1000 Series

---

Gateway functions Manual

for GT Works3

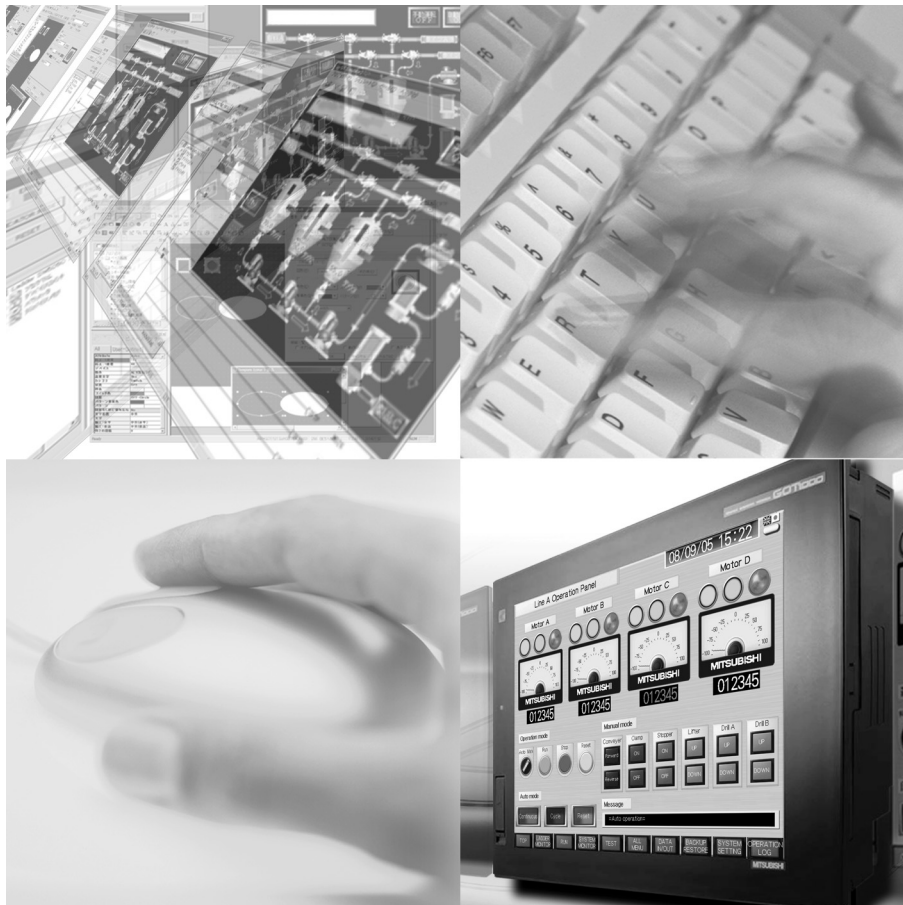



# ● SAFETY PRECAUTIONS ●

(Always read these instructions before using this equipment.)

Before using this product, please read this manual and the relevant manuals introduced in this manual carefully and pay full attention to safety to handle the product correctly.

The precautions given in this manual are concerned with this product.

In this manual, the safety precautions are ranked as "WARNING" and "CAUTION".



Indicates that incorrect handling may cause hazardous conditions, resulting in death or severe injury.



CAUTION Indicates that incorrect handling may cause hazardous conditions, resulting in minor or moderate injury or property damage.

Note that the  caution level may lead to a serious accident according to the circumstances. Always follow the instructions of both levels because they are important to personal safety.

Please save this manual to make it accessible when required and always forward it to the end user.

## [Precautions for test operation]

### **WARNING**

- Before starting the test operation for the system monitor or ladder monitor (bit device ON/OFF, word device present value changing, timer/counter set value/present value changing, buffer memory present value changing), please read the manual carefully to fully understand the operation methods.

For devices that perform significant operations for the system, never perform test operation to change data.

Doing so can cause accidents due to false outputs or malfunctions.

## INTRODUCTION

Thank you for choosing the Mitsubishi Graphic Operation Terminal (Mitsubishi GOT).  
Read this manual and make sure you understand the functions and performance of the GOT thoroughly in advance to ensure correct use.

## CONTENTS

SAFETY PRECAUTIONS .....	A - 1
INTRODUCTION .....	A - 2
CONTENTS .....	A - 2
MANUALS.....	A - 5
QUICK REFERENCE .....	A - 7
ABBREVIATIONS AND GENERIC TERMS .....	A - 9
HOW TO READ THIS MANUAL .....	A - 14
ARROW SYMBOLS USED IN ILLUSTRATIONS .....	A - 14

### 1. OVERVIEW

---

1.1 Features of Server and Client Functions .....	1 - 1
1.2 Features of Mail Send Function .....	1 - 5
1.3 Features of FTP Server Function .....	1 - 6
1.4 Features of File Transfer Function (FTP Client) .....	1 - 8

### 2. SYSTEM CONFIGURATION

---

2.1 System Configuration of Gateway Functions.....	2 - 1
2.2 Types of Controller to GOT Connection .....	2 - 2
2.3 Communication Interface Setting.....	2 - 4
2.4 Precautions for System Configuration .....	2 - 6

### 3. GENERAL PROCEDURE TO BE FOLLOWED FOR USING

---

### 4. SERVER AND CLIENT FUNCTIONS

---

4.1 Gateway Devices.....	4 - 1
4.1.1 What are the gateway devices?.....	4 - 1
4.1.2 Usable gateway devices .....	4 - 2
4.1.3 How to monitor the gateway devices .....	4 - 3
4.1.4 Controller devices that can be assigned.....	4 - 7
4.2 Specifications.....	4 - 10
4.2.1 Specifications.....	4 - 10
4.2.2 Access range that can be monitored .....	4 - 10
4.3 System Configuration .....	4 - 13
4.4 Setting Method.....	4 - 14
4.5 Examples of Use.....	4 - 17
4.6 Precautions .....	4 - 22
4.7 For Efficient Use .....	4 - 24

## 5. MAIL SEND FUNCTION

---

5.1	Specifications.....	5 - 2
5.1.1	Specifications .....	5 - 2
5.1.2	Mail send enabled range .....	5 - 3
5.2	System Configuration .....	5 - 4
5.3	Setting Method.....	5 - 5
5.4	Mail Send Examples .....	5 - 6
5.5	Examples of Use.....	5 - 7
5.6	Precautions.....	5 - 8

## 6. FTP SERVER FUNCTION

---

6.1	Specifications.....	6 - 1
6.1.1	Specifications .....	6 - 1
6.1.2	Accessible file range.....	6 - 2
6.2	System Configuration .....	6 - 3
6.3	Setting Method.....	6 - 4
6.4	Operation on FTP Client Side.....	6 - 5
6.4.1	Input command at FTP client.....	6 - 5
6.4.2	File specifying method.....	6 - 6
6.4.3	Checking the line connection status .....	6 - 8
6.4.4	Line disconnection.....	6 - 9
6.5	Example of Use .....	6 - 10
6.6	Precautions.....	6 - 14

## 7. FILE TRANSFER FUNCTION (FTP CLIENT)

---

7.1	Specifications.....	7 - 1
7.1.1	Specifications .....	7 - 1
7.1.2	Accessible file range.....	7 - 2
7.2	System Configuration .....	7 - 3
7.3	Setting Method.....	7 - 4
7.3.1	GOT (FTP client) setting.....	7 - 4
7.3.2	FTP server setting .....	7 - 12
7.4	Confirmation of Processing Status .....	7 - 13
7.5	Examples of Use.....	7 - 14
7.6	Precautions.....	7 - 16

## 8. TROUBLESHOOTING

---

8.1	Troubleshooting Common to Gateway Functions.....	8 - 1
8.2	Gateway Information.....	8 - 2
8.3	Server and Client Functions .....	8 - 4
8.3.1	Error codes and error messages .....	8 - 4
8.3.2	Troubleshooting.....	8 - 5
8.4	Mail Send Function .....	8 - 6
8.4.1	Error codes and error messages.....	8 - 6
8.4.2	Troubleshooting.....	8 - 6
8.5	FTP Server Function.....	8 - 7

8.5.1	Error codes and error messages .....	8 - 7
8.5.2	Troubleshooting .....	8 - 8
8.6	File Transfer Function (FTP Client) .....	8 - 9
8.6.1	Error codes and error messages .....	8 - 9
8.6.2	Troubleshooting .....	8 - 10

## **INDEX**

---

## **REVISIONS**

---

## MANUALS

The following table lists the manual relevant to this product.  
Refer to each manual for any purpose.

### ■ Screen creation software manuals

Manual Name	Packaging	Manual Number (Model code)
GT Works3 Version1 Installation Procedure Manual	Enclosed in product	-
GT Designer3 Version1 Screen Design Manual (Fundamentals) 1/2, 2/2	Stored in CD-ROM	SH-080866ENG (1D7MB9)
GT Designer3 Version1 Screen Design Manual (Functions) 1/2, 2/2	Stored in CD-ROM	SH-080867ENG (1D7MC1)
GT Simulator3 Version1 Operating Manual for GT Works3	Stored in CD-ROM	SH-080861ENG (1D7MB1)
GT Converter2 Version3 Operating Manual for GT Works3	Stored in CD-ROM	SH-080862ENG (1D7MB2)

### ■ Connection manuals

Manual Name	Packaging	Manual Number (Model code)
GOT1000 Series Connection Manual (Mitsubishi Products) for GT Works3	Stored in CD-ROM	SH-080868ENG (1D7MC2)
GOT1000 Series Connection Manual (Non-Mitsubishi Products 1) for GT Works3	Stored in CD-ROM	SH-080869ENG (1D7MC3)
GOT1000 Series Connection Manual (Non-Mitsubishi Products 2) for GT Works3	Stored in CD-ROM	SH-080870ENG (1D7MC4)
GOT1000 Series Connection Manual (Microcomputer, MODBUS Products, Peripherals) for GT Works3	Stored in CD-ROM	SH-080871ENG (1D7MC5)

### ■ Extended and option function manuals

Manual Name	Packaging	Manual Number (Model code)
GOT1000 Series Gateway Functions Manual for GT Works3	Stored in CD-ROM	SH-080858ENG (1D7MA7)
GOT1000 Series MES Interface Function Manual for GT Works3	Stored in CD-ROM	SH-080859ENG (1D7MA8)
GOT1000 Series User's Manual (Extended Functions, Option Functions) for GT Works3	Stored in CD-ROM	SH-080863ENG (1D7MB3)

### ■ GT SoftGOT1000 manuals

Manual Name	Packaging	Manual Number (Model code)
GT SoftGOT1000 Version3 Operating Manual for GT Works3	Stored in CD-ROM	SH-080860ENG (1D7MA9)

## ■ GT16 manuals

Manual Name	Packaging	Manual Number (Model code)
GT16 User's Manual (Hardware)	Stored in CD-ROM	SH-080928ENG (1D7MD3)
GT16 User's Manual (Basic Utility)	Stored in CD-ROM	SH-080929ENG (1D7MD4)
GT16 Handy GOT User's Manual	Stored in CD-ROM	JY997D41201 JY997D41202 (09R821)

## ■ GT15 manuals

Manual Name	Packaging	Manual Number (Model code)
GT15 User's Manual	Stored in CD-ROM	SH-080528ENG (1D7M23)

## ■ GT14 manuals

Manual Name	Packaging	Manual Number (Model code)
GT14 User's Manual	Stored in CD-ROM	JY997D44801 (09R823)

## ■ GT12 manuals

Manual Name	Packaging	Manual Number (Model code)
GT12 User's Manual	Stored in CD-ROM	SH-080977ENG (1D7ME1)

## ■ GT11 manuals

Manual Name	Packaging	Manual Number (Model code)
GT11 User's Manual	Stored in CD-ROM	JY997D17501 (09R815)
GT11 Handy GOT User's Manual	Stored in CD-ROM	JY997D20101 JY997D20102 (09R817)

## ■ GT10 manuals

Manual Name	Packaging	Manual Number (Model code)
GT10 User's Manual	Stored in CD-ROM	JY997D24701 (09R819)



## **QUICK REFERENCE**

### **■ Creating a project**

Obtaining the specifications and operation methods of GT Designer3	GT Designer3 Version1 Screen Design Manual (Fundamentals) 1/2, 2/2
Setting available functions on GT Designer3	
Creating a screen displayed on the GOT	
Obtaining useful functions to increase efficiency of drawing	
Setting details for figures and objects	GT Designer3 Version1 Screen Design Manual (Functions) 1/2, 2/2
Setting functions for the data collection or trigger action	
Setting functions to use peripheral devices	
Simulating a created project on a personal computer	GT Simulator3 Version1 Operating Manual for GT Works3

### **■ Connecting a controller to the GOT**

Obtaining information of Mitsubishi products applicable to the GOT	GOT1000 Series Connection Manual (Mitsubishi Products) for GT Works3
Connecting Mitsubishi products to the GOT	
Connecting multiple controllers to one GOT (Multi-channel function)	
Establishing communication between a personal computer and a controller via the GOT (FA transparent function)	
Obtaining information of Non-Mitsubishi products applicable to the GOT	• GOT1000 Series Connection Manual (Non-Mitsubishi Products 1) for GT Works3 • GOT1000 Series Connection Manual (Non-Mitsubishi Products 2) for GT Works3
Connecting Non-Mitsubishi products to the GOT	
Obtaining information of peripheral devices applicable to the GOT	GOT1000 Series Connection Manual (Microcomputer, MODBUS Products, Peripherals) for GT Works3
Connecting peripheral devices including a barcode reader to the GOT	

### **■ Transferring data to the GOT**

Writing data to the GOT	GT Designer3 Version1 Screen Design Manual (Fundamentals) 1/2, 2/2
Reading data from the GOT	
Verifying a editing project to a GOT project	

## ■ Others

Obtaining specifications (including part names, external dimensions, and options) of each GOT	<ul style="list-style-type: none"><li>• GT16 User's Manual (Hardware)</li><li>• GT16 Handy GOT User's Manual</li><li>• GT15 User's Manual</li><li>• GT14 User's Manual</li><li>• GT12 User's Manual</li><li>• GT11 User's Manual</li><li>• GT11 Handy GOT User's Manual</li><li>• GT10 User's Manual</li></ul>
Installing the GOT	
Operating the utility	<ul style="list-style-type: none"><li>• GT16 User's Manual (Basic Utility)</li><li>• GT16 Handy GOT User's Manual</li><li>• GT15 User's Manual</li><li>• GT14 User's Manual</li><li>• GT12 User's Manual</li><li>• GT11 User's Manual</li><li>• GT11 Handy GOT User's Manual</li><li>• GT10 User's Manual</li></ul>
Configuring the gateway function	GOT1000 Series Gateway Functions Manual for GT Works3
Configuring the MES interface function	GOT1000 Series MES Interface Function Manual for GT Works3
Configuring the extended function and option function	GOT1000 Series User's Manual (Extended Functions, Option Functions) for GT Works3
Using a personal computer as the GOT	GT SoftGOT1000 Version3 Operating Manual for GT Works3

## ABBREVIATIONS AND GENERIC TERMS

### ■ GOT

Abbreviations and generic terms		Description
GT1695	GT1695M-X	Abbreviation of GT1695M-XTBA, GT1695M-XTBD
GT1685	GT1685M-S	Abbreviation of GT1685M-STBA, GT1685M-STBD
GT1675	GT1675M-S	Abbreviation of GT1675M-STBA, GT1675M-STBD
	GT1675M-V	Abbreviation of GT1675M-VTBA, GT1675M-VTBD
	GT1675-VN	Abbreviation of GT1675-VNBA, GT1675-VNBD
GT1672	GT1672-VN	Abbreviation of GT1672-VNBA, GT1672-VNBD
GT1665	GT1665M-S	Abbreviation of GT1665M-STBA, GT1665M-STBD
	GT1665M-V	Abbreviation of GT1665M-VTBA, GT1665M-VTBD
GT1662	GT1662-VN	Abbreviation of GT1662-VNBA, GT1662-VNBD
GT1655	GT1655-V	Abbreviation of GT1655-VTBD
GT16		Abbreviation of GT1695, GT1685, GT1675, GT1672, GT1665, GT1662, GT1655, GT16 Handy GOT
GT1595	GT1595-X	Abbreviation of GT1595-XTBA, GT1595-XTBD
GT1585	GT1585V-S	Abbreviation of GT1585V-STBA, GT1585V-STBD
	GT1585-S	Abbreviation of GT1585-STBA, GT1585-STBD
GT157□	GT1575V-S	Abbreviation of GT1575V-STBA, GT1575V-STBD
	GT1575-S	Abbreviation of GT1575-STBA, GT1575-STBD
	GT1575-V	Abbreviation of GT1575-VTBA, GT1575-VTBD
	GT1575-VN	Abbreviation of GT1575-VNBA, GT1575-VNBD
	GT1572-VN	Abbreviation of GT1572-VNBA, GT1572-VNBD
GT156□	GT1565-V	Abbreviation of GT1565-VTBA, GT1565-VTBD
	GT1562-VN	Abbreviation of GT1562-VNBA, GT1562-VNBD
GT155□	GT1555-V	Abbreviation of GT1555-VTBD
	GT1555-Q	Abbreviation of GT1555-QTBD, GT1555-QSBD
	GT1550-Q	Abbreviation of GT1550-QLBD
GT15		Abbreviation of GT1595, GT1585, GT157□, GT156□, GT155□
GT145□	GT1455-Q	Abbreviation of GT1455-QTBDE, GT1455-QTBD
	GT1450-Q	Abbreviation of GT1450-QMBDE, GT1450-QMBD, GT1450-QLBDE, GT1450-QLBD
GT14		Abbreviation of GT1455-Q, GT1450-Q
GT1275	GT1275-V	Abbreviation of GT1275-VNBA, GT1275-VNBD
GT1265	GT1265-V	Abbreviation of GT1265-VNBA, GT1265-VNBD
GT12		Abbreviation of GT1275, GT1265
GT115□	GT1155-Q	Abbreviation of GT1155-QTBDQ, GT1155-QSBDQ, GT1155-QTBDA, GT1155-QSBDA, GT1155-QTBD, GT1155-QSBD
	GT1150-Q	Abbreviation of GT1150-QLBDQ, GT1150-QLBDA, GT1150-QLBD
GT11		Abbreviation of GT115□, GT11 Handy GOT,
GT105□	GT1055-Q	Abbreviation of GT1055-QSBD
	GT1050-Q	Abbreviation of GT1050-QBBD
GT104□	GT1045-Q	Abbreviation of GT1045-QSBD
	GT1040-Q	Abbreviation of GT1040-QBBD
GT1030		Abbreviation of GT1030-LBD, GT1030-LBD2, GT1030-LBL, GT1030-LBDW, GT1030-LBDW2, GT1030-LBLW, GT1030-LWD, GT1030-LWD2, GT1030-LWL, GT1030-LWDW, GT1030-LWDW2, GT1030-LWLW, GT1030-HBD, GT1030-HBD2, GT1030-HBL, GT1030-HBDW, GT1030-HBDW2, GT1030-HBLW, GT1030-HWD, GT1030-HWD2, GT1030-HWL, GT1030-HWDW, GT1030-HWDW2, GT1030-HWLW
GT1020		Abbreviation of GT1020-LBD, GT1020-LBD2, GT1020-LBL, GT1020-LBDW, GT1020-LBDW2, GT1020-LBLW, GT1020-LWD, GT1020-LWD2, GT1020-LWL, GT1020-LWDW, GT1020-LWDW2, GT1020-LWLW
GT10		Abbreviation of GT105□, GT104□, GT1030, GT1020

GOT1000  
Series

Abbreviations and generic terms				Description
GOT1000 Series	Handy GOT	GT16 Handy GOT	GT1665HS-V	Abbreviation of GT1665HS-VTBD
		GT11 Handy GOT	GT1155HS-Q	Abbreviation of GT1155HS-QSBD
			GT1150HS-Q	Abbreviation of GT1150HS-QLBD
	GT SoftGOT1000			Abbreviation of GT SoftGOT1000
GOT900 Series				Abbreviation of GOT-A900 series, GOT-F900 series
GOT800 Series				Abbreviation of GOT-800 series

## ■ Communication unit

Abbreviations and generic terms		Description
Bus connection unit		GT15-QBUS, GT15-QBUS2, GT15-ABUS, GT15-ABUS2, GT15-75QBUSL, GT15-75QBUS2L, GT15-75ABUSL, GT15-75ABUS2L
Serial communication unit		GT15-RS2-9P, GT15-RS4-9S, GT15-RS4-TE
RS-422 conversion unit		GT15-RS2T4-9P, GT15-RS2T4-25P
Ethernet communication unit		GT15-J71E71-100
MELSECNET/H communication unit		GT15-J71LP23-25, GT15-J71BR13
MELSECNET/10 communication unit		GT15-75J71LP23-Z <sup>*1</sup> , GT15-75J71BR13-Z <sup>*2</sup>
CC-Link IE Controller Network communication unit		GT15-J71GP23-SX
CC-Link IE Field Network communication unit		GT15-J71GF13-T2
CC-Link communication unit		GT15-J61BT13, GT15-75J61BT13-Z <sup>*3</sup>
Interface converter unit		GT15-75IF900
Serial multi-drop connection unit		GT01-RS4-M
Connection Conversion Adapter		GT10-9PT5S
RS-232/485 signal conversion adapter		GT14-RS2T4-9P

\*1 A9GT-QJ71LP23 + GT15-75IF900 set

\*2 A9GT-QJ71BR13 + GT15-75IF900 set

\*3 A8GT-J61BT13 + GT15-75IF900 set

## ■ Option unit

Abbreviations and generic terms		Description
Printer unit		GT15-PRN
Video/RGB unit	Video input unit	GT16M-V4, GT15V-75V4
	RGB input unit	GT16M-R2, GT15V-75R1
	Video/RGB input unit	GT16M-V4R1, GT15V-75V4R1
	RGB output unit	GT16M-ROUT, GT15V-75ROUT
Multimedia unit		GT16M-MMR
CF card unit		GT15-CFCD
CF card extension unit <sup>*1</sup>		GT15-CFEX-C08SET
External I/O unit		GT15-DIO, GT15-DIOR
Sound output unit		GT15-SOUT

\*1 GT15-CFEX + GT15-CFEXIF + GT15-C08CF set.

## ■ Option

Abbreviations and generic terms		Description
Memory card	CF card	GT05-MEM-16MC, GT05-MEM-32MC, GT05-MEM-64MC, GT05-MEM-128MC, GT05-MEM-256MC, GT05-MEM-512MC, GT05-MEM-1GC, GT05-MEM-2GC, GT05-MEM-4GC, GT05-MEM-8GC, GT05-MEM-16GC
	SD card	NZ1MEM-2GBSD, NZ1MEM-4GBSD, NZ1MEM-8GBSD, NZ1MEM-16GBSD, L1MEM-2GBSD, L1MEM-4GBSD
Memory card adaptor		GT05-MEM-ADPC
Option function board		GT16-MESB, GT15-FNB, GT15-QFNB, GT15-QFNB16M, GT15-QFNB32M, GT15-QFNB48M, GT11-50FNB, GT15-MESB48M
Battery		GT15-BAT, GT11-50BAT
Protective Sheet	For GT16	GT16-90PSCB, GT16-90PSGB, GT16-90PSCW, GT16-90PSGW, GT16-80PSCB, GT16-80PSGB, GT16-80PSCW, GT16-80PSGW, GT16-70PSCB, GT16-70PSGB, GT16-70PSCW, GT16-70PSGW, GT16-60PSCB, GT16-60PSGB, GT16-60PSCW, GT16-60PSGW, GT16-50PSCB, GT16-50PSGB, GT16-50PSCW, GT16-50PSGW, GT16-90PSCB-012, GT16-80PSCB-012, GT16-70PSCB-012, GT16-60PSCB-012, GT16-50PSCB-012, GT16H-60PSC
	For GT15	GT15-90PSCB, GT15-90PSGB, GT15-90PSCW, GT15-90PSGW, GT15-80PSCB, GT15-80PSGB, GT15-80PSCW, GT15-80PSGW, GT15-70PSCB, GT15-70PSGB, GT15-70PSCW, GT15-70PSGW, GT15-60PSCB, GT15-60PSGB, GT15-60PSCW, GT15-60PSGW, GT15-50PSCB, GT15-50PSGB, GT15-50PSCW, GT15-50PSGW
	For GT14	GT14-50PSCB, GT14-50PSGB, GT14-50PSCW, GT14-50PSGW
	For GT12	GT11-70PSCB, GT11-65PSCB
	For GT11	GT11-50PSCB, GT11-50PSGB, GT11-50PSCW, GT11-50PSGW, GT11H-50PSC
	For GT10	GT10-50PSCB, GT10-50PSGB, GT10-50PSCW, GT10-50PSGW, GT10-40PSCB, GT10-40PSGB, GT10-40PSCW, GT10-40PSGW, GT10-30PSCB, GT10-30PSGB, GT10-30PSCW, GT10-30PSGW, GT10-20PSCB, GT10-20PSGB, GT10-20PSCW, GT10-20PSGW
Protective cover for oil		GT05-90PCO, GT05-80PCO, GT05-70PCO, GT05-60PCO, GT05-50PCO, GT16-50PCO, GT10-40PCO, GT10-30PCO, GT10-20PCO
USB environmental protection cover		GT16-UCOV, GT16-50UCOV, GT15-UCOV, GT14-50UCOV, GT11-50UCOV
Stand		GT15-90STAND, GT15-80STAND, GT15-70STAND, A9GT-50STAND, GT05-50STAND
Attachment		GT15-70ATT-98, GT15-70ATT-87, GT15-60ATT-97, GT15-60ATT-96, GT15-60ATT-87, GT15-60ATT-77, GT15-50ATT-95W, GT15-50ATT-85
Backlight		GT16-90XLTT, GT16-80SLTT, GT16-70SLTT, GT16-70VLTT, GT16-70VLTTA, GT16-70VLTN, GT16-60SLTT, GT16-60VLTT, GT16-60VLTN, GT15-90XLTT, GT15-80SLTT, GT15-70SLTT, GT15-70VLTT, GT15-70VLTN, GT15-60VLTT, GT15-60VLTN
Multi-color display board		GT15-XHNB, GT15-VHNB
Connector conversion box		GT11H-CNB-37S, GT16H-CNB-42S
Emergency stop sw guard cover		GT11H-50ESCOV, GT16H-60ESCOV
Wall-hanging fitting		GT14H-50ATT
Memory loader		GT10-LDR
Memory board		GT10-50FMB
Panel-mounted USB port extension		GT14-C10EXUSB-4S, GT10-C10EXUSB-5S

## ■ Software

Abbreviations and generic terms		Description
GT Works3		Abbreviation of the SW□DND-GTWK3-E and SW□DND-GTWK3-EA
GT Designer3		Abbreviation of screen drawing software GT Designer3 for GOT1000 series
GT Simulator3		Abbreviation of screen simulator GT Simulator3 for GOT1000/GOT900 series
GT SoftGOT1000		Abbreviation of monitoring software GT SoftGOT1000
GT Converter2		Abbreviation of data conversion software GT Converter2 for GOT1000/GOT900 series
GT Designer2 Classic		Abbreviation of screen drawing software GT Designer2 Classic for GOT900 series
GT Designer2		Abbreviation of screen drawing software GT Designer2 for GOT1000/GOT900 series
iQ Works		Abbreviation of iQ Platform compatible engineering environment MELSOFT iQ Works
MELSOFT Navigator		Generic term for integrated development environment software included in the SW□DNC-IQWK (iQ Platform compatible engineering environment MELSOFT iQ Works)
GX Works3		Abbreviation of SW□DND-GXW3-E and SW□DND-GXW3-EA type programmable controller engineering software
GX Works2		Abbreviation of SW□DNC-GXW2-E and SW□DNC-GXW2-EA type programmable controller engineering software
Controller simulator	GX Simulator3	Abbreviation of GX Works3 with the simulation function
	GX Simulator2	Abbreviation of GX Works2 with the simulation function
	GX Simulator	Abbreviation of SW□D5C-LLT-E(-EV) type ladder logic test tool function software packages (SW5D5C-LLT (-EV) or later versions)
GX Developer		Abbreviation of SW□D5C-GPPW-E(-EV)/SW D5F-GPPW-E type software package
GX LogViewer		Abbreviation of SW□DNN-VIEWER-E type software package
PX Developer		Abbreviation of SW□D5C-FBDQ-E type FBD software package for process control
MT Works2		Abbreviation of motion controller engineering environment MELSOFT MT Works2(SW□DND-MTW2-E)
MT Developer		Abbreviation of SW□RNC-GSV type integrated start-up support software for motion controller Q series
MR Configurator2		Abbreviation of SW□DNC-MRC2-E type Servo Configuration Software
MR Configurator		Abbreviation of MRZJW□-SETUP□E type Servo Configuration Software
FR Configurator		Abbreviation of Inverter Setup Software (FR-SW□-SETUP-WE)
NC Configurator		Abbreviation of CNC parameter setting support tool NC Configurator
FX Configurator-FP		Abbreviation of parameter setting, monitoring, and testing software packages for FX3U-20SSC-H (SW□D5C-FXSSC-E)
FX3U-ENET-L Configuration tool		Abbreviation of FX3U-ENET-L type Ethernet module setting software (SW1D5-FXENETL-E)
RT ToolBox2		Abbreviation of robot program creation software (3D-11C-WINE)
MX Component		Abbreviation of MX Component Version□ (SW□D5C-ACT-E, SW□D5C-ACT-EA)
MX Sheet		Abbreviation of MX Sheet Version□ (SW□D5C-SHEET-E, SW□D5C-SHEET-EA)
CPU Module Logging Configuration Tool		Abbreviation of CPU Module Logging Configuration Tool (SW1DNN-LLUTL-E)

## ■ License key (for GT SoftGOT1000)

Abbreviations and generic terms	Description
License	GT15-SGTKEY-U, GT15-SGTKEY-P

## ■ Others

Abbreviations and generic terms	Description
IAI	Abbreviation of IAI Corporation
AZBIL	Abbreviation of Azbil Corporation (former Yamatake Corporation)
OMRON	Abbreviation of OMRON Corporation
KEYENCE	Abbreviation of KEYENCE CORPORATION
KOYO EI	Abbreviation of KOYO ELECTRONICS INDUSTRIES CO., LTD.
SHARP	Abbreviation of Sharp Manufacturing Systems Corporation
JTEKT	Abbreviation of JTEKT Corporation
SHINKO	Abbreviation of Shinko Technos Co., Ltd.
CHINO	Abbreviation of CHINO CORPORATION
TOSHIBA	Abbreviation of TOSHIBA CORPORATION
TOSHIBA MACHINE	Abbreviation of TOSHIBA MACHINE CO., LTD.
HITACHI IES	Abbreviation of Hitachi Industrial Equipment Systems Co., Ltd.
HITACHI	Abbreviation of Hitachi, Ltd.
FUJI	Abbreviation of FUJI ELECTRIC CO., LTD.
PANASONIC	Abbreviation of Panasonic Corporation
PANASONIC INDUSTRIAL DEVICES SUNX	Abbreviation of Panasonic Industrial Devices SUNX Co., Ltd.
YASKAWA	Abbreviation of YASKAWA Electric Corporation
YOKOGAWA	Abbreviation of Yokogawa Electric Corporation
ALLEN-BRADLEY	Abbreviation of Allen-Bradley products manufactured by Rockwell Automation, Inc.
GE	Abbreviation of GE Intelligent Platforms
LS IS	Abbreviation of LS Industrial Systems Co., Ltd.
MITSUBISHI INDIA	Mitsubishi Electric India Pvt. Ltd.
SCHNEIDER	Abbreviation of Schneider Electric SA
SICK	Abbreviation of SICK AG
SIEMENS	Abbreviation of Siemens AG
RKC	Abbreviation of RKC INSTRUMENT INC.
HIRATA	Abbreviation of Hirata Corporation
MURATEC	Abbreviation of Muratec products manufactured by Muratec Automation Co., Ltd.
PLC	Abbreviation of programmable controller
Temperature controller	Generic term for temperature controller manufactured by each corporation
Indicating controller	Generic term for indicating controller manufactured by each corporation
Control equipment	Generic term for control equipment manufactured by each corporation
CHINO controller	Abbreviation of indicating controller manufactured by CHINO CORPORATION
PC CPU module	Abbreviation of PC CPU Unit manufactured by CONTEC CO., LTD
GOT (server)	Abbreviation of GOTs that use the server function
GOT (client)	Abbreviation of GOTs that use the client function
Windows® font	Abbreviation of TrueType font and OpenType font available for Windows® (Differs from the True Type fonts settable with GT Designer3)
Intelligent function module	Indicates the modules other than the PLC CPU, power supply module and I/O module that are mounted to the base unit
MODBUS® /RTU	Generic term for the protocol designed to use MODBUS® protocol messages on a serial communication
MODBUS® /TCP	Generic term for the protocol designed to use MODBUS® protocol messages on a TCP/IP network

# HOW TO READ THIS MANUAL

Following symbols are used in this manual.

## 6.3 Setting Method

1. Select [Common] → [Controller Setting] from the menu to display the Controller Setting dialog box.
2. Select [FTP Server] and set the required items.

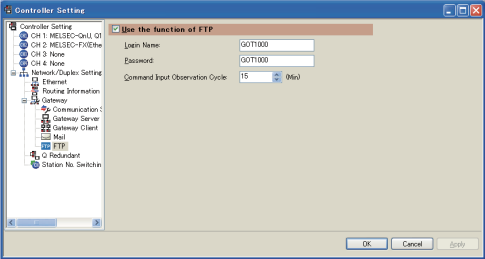

Item	Description
Use the function of FTP Server	Check this item when using the FTP server function.
Login Name	Set the login name used when the FTP client connects to the GOT. Only one login name and the login name up to max. 12 characters can be set. Only alphanumeric characters (a to z, A to Z, 0 to 9) can be used. The default is GOT1000.
Password	Set the password used when the FTP client connects to the GOT. Only one password and the password up to max. 8 characters can be set. Only alphanumeric characters (a to z, A to Z, 0 to 9) can be used. The default is GOT1000.
Command Input Observation Cycle	Set the time when the line with the GOT will be disconnected if no command is entered from the FTP client. The time can set in the range from 1 to 60 min. in 1 min. increments. Normally, use the default setting (15 min).

**POINT**

**Details about the script function**  
Refer to the following manual for details of the script function.

GT Designer 3 Version1 Screen Design Manual (Functions)

For examples of using the script function, refer to Section 4.4 of this manual.

This chapter describes the general procedure to be followed for using the gateway functions.

1. Examine the configuration of the whole system.
  - Connection structure of the whole system such as the controllers and GOTs
  - Controller setting (device assignment, etc.)
  - GOT setting (IP address, network number, station number, etc.)
2. Connect GOT and controllers.
  - GOT1000 Series Connection Manual for GT Works3 and a controller used
3. Establish a system for the gateway function to be used.

- 1 OVERVIEW
- 2 SYSTEM CONFIGURATION
- 3 OPERATION SEQUENCE
- 4 SERVER AND CLIENT FUNCTIONS
- 5 MAIN SEND FUNCTION
- 6 FTP SERVER FUNCTION
- 7 TROUBLE SHOOTING
- INDEX

[ ] : Shows the setting item displayed on the software screen or the GOT screen.

**POINT** Refers to information required for operation.

**HINT** Refers to information useful for operation.

Shows a chapter, section, relevant manual, or others of relevant information.

Shows the operation steps.  
Operate the steps from the step 1.

\*Since the above page was created for explanation purpose, it differs from the actual page.

## ARROW SYMBOLS USED IN ILLUSTRATIONS

Arrow symbols used in the illustrations in this manual indicate the type of communications as below:

Symbol	Description
	Indicates communications in which a GOT monitors the controllers.
	Indicates communications in the communication format of individual PLC makers.
	Indicates communications that uses the server and client functions.



# 1. OVERVIEW

This manual explains the gateway functions.

The gateway functions include the functions below to support remote monitoring and remote maintenance of the production site from the office.

- Server function
- Client function
- Mail send function
- FTP server function
- File transfer function (FTP client)

## 1.1 Features of Server and Client Functions



### ■ Collection of data by personal computer (server)

By monitoring the GOTs (server), the personal computer (MX Component) can indirectly read/write data from/to the devices of the controllers being monitored by the GOTs.

The server function enables data to be read/written with only the MX Component even if the controller of a different maker is monitored, and the communication method is standardized to Ethernet.

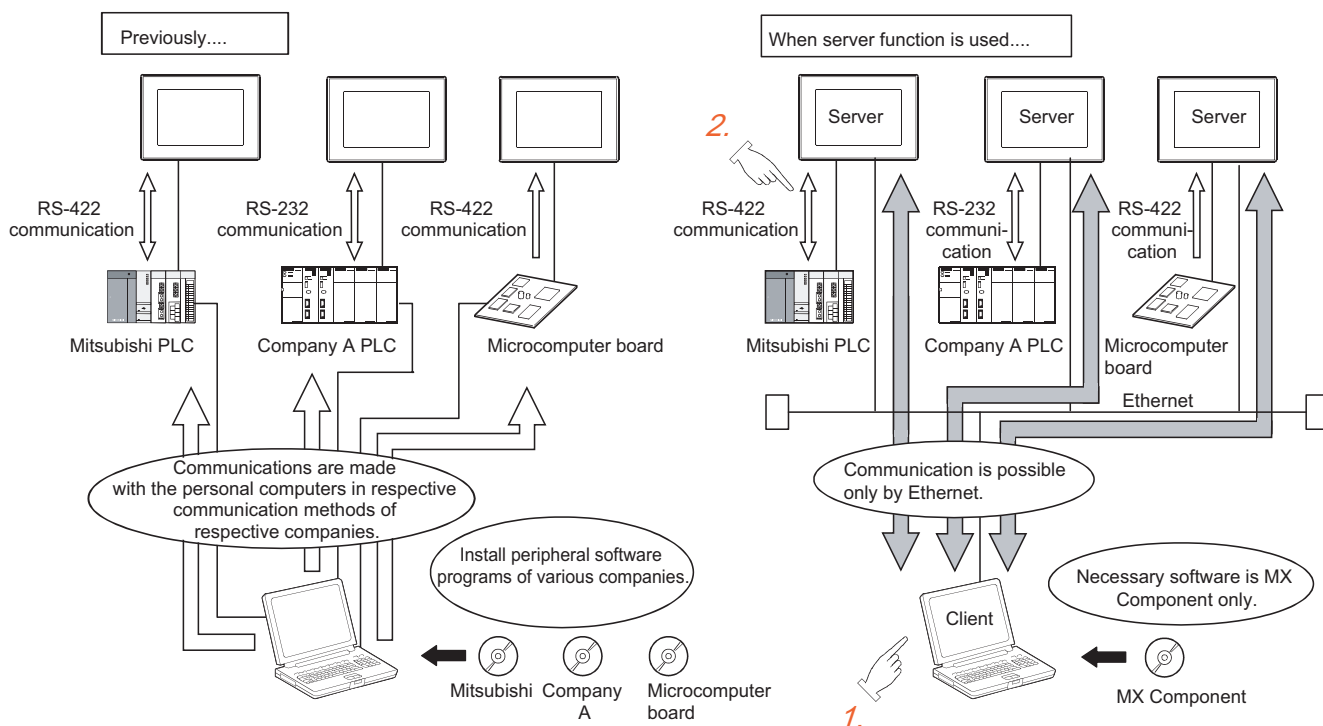

<Processing when writing data from a personal computer to controller devices>

1. Data is written to the gateway device of the GOT (server) by running the user program, which is created by MX Component.
2. The data is then written to the controller device assigned to the gateway device.

## ■ Monitoring of other GOTs from client GOT (server and client)

By monitoring the GOTs (server), the GOT (client) can indirectly read/write data from/to the devices of the controllers being monitored by the GOTs (server).

Use of the client function enables data to be read/written indirectly from/to the PLC CPUs of various makers that are different from the maker of the controller connected to the GOT (client).

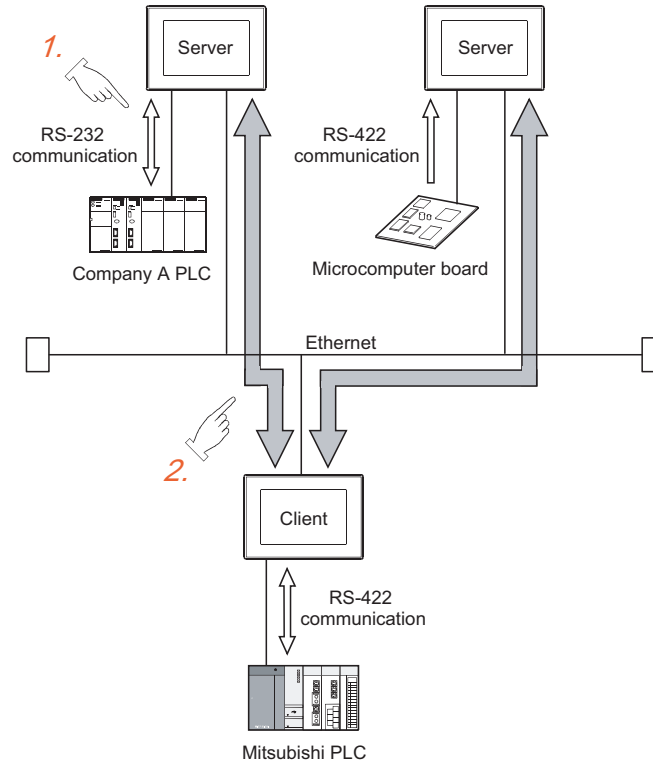

<Processing when reading data by GOT (client) from controller devices>

1. The GOT (server) monitors the devices of controller.
2. The GOT (client) can indirectly read data from the devices of the controller, monitored as explained in procedure 1., by monitoring the gateway device of the GOT (server).

## ■ Simultaneous use of the server and client functions

Setting of the server and client functions to a single GOT enables the GOT to send data to the personal computer (client) while collecting data from other GOT (server).

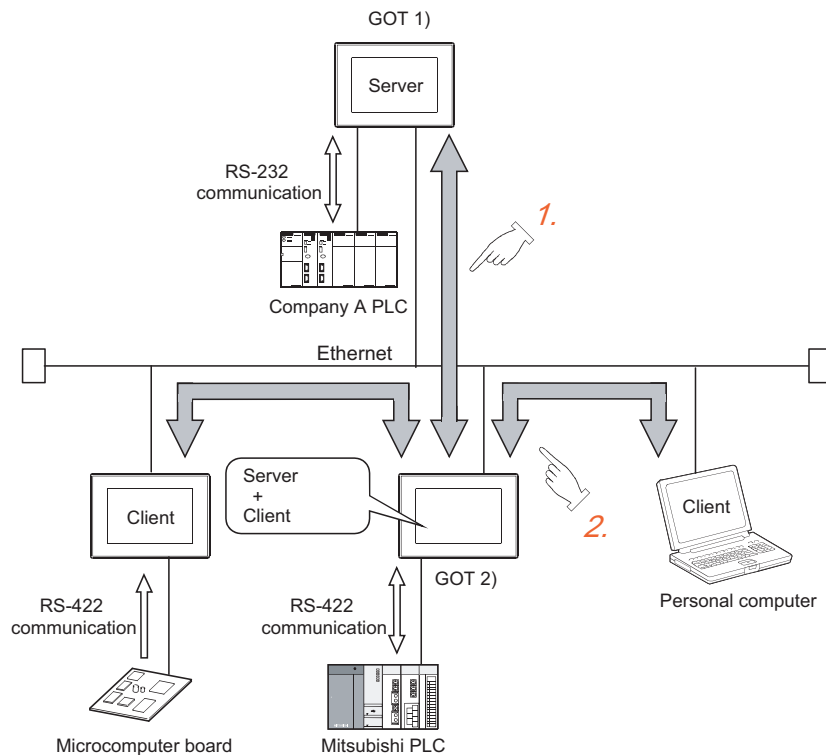

1. Using the client function, GOT 2) collects data from GOT 1).
2. The client GOT or the personal computer sends read/write request to GOT 2) (server).

## ■ Communication enabled between GOT1000 and GOT-A900

In the system configured using GOT-A900s, it is possible to add a GOT1000 to the system or also replace a GOT-A900 with a GOT1000.

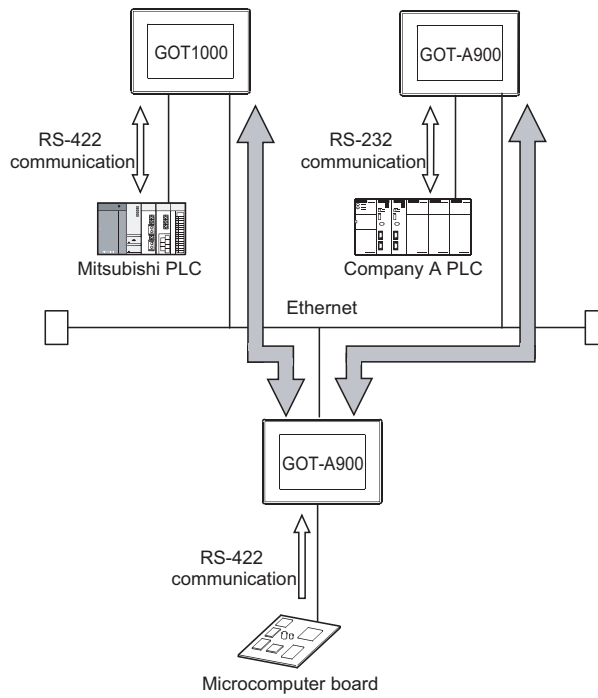

## 1.2 Features of Mail Send Function



Using the alarm history display function, you can send the occurrence or recovery information of an error to a computer or cellular phone by mail at the time of the occurrence or the recovery from an error.

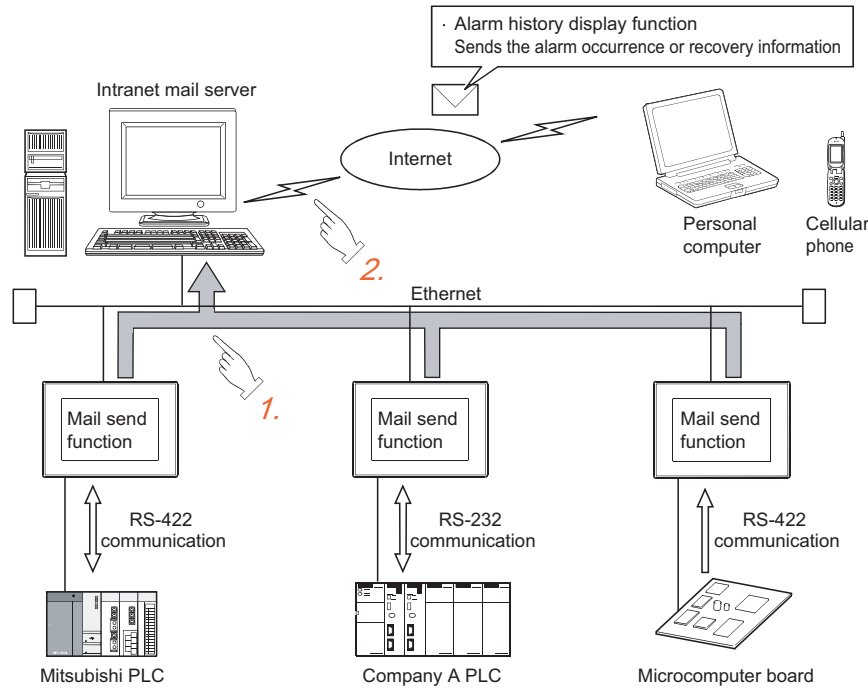

1. The GOT sends the mail send request to the intranet mail server using the alarm history display function.
2. In response to the request sent from the GOT, the intranet mail server sends mail to a computer or cellular phone.

## 1.3 Features of FTP Server Function



The FTP server function uses the GOT as an FTP server, and reads files from/writes files to an external FTP client. Files such as resource data can be read from/written to GOT (FTP server) via Ethernet, by an operation from the personal computer (FTP client).

The following files can be read/written by the FTP server function.

- CSV files
- Unicode text files
- Image data (JPEG files)
- Binary format files (\*.G1□)

### POINT

#### (1) Data which cannot be written to GOT

Do not write CSV files or Unicode text files into the GOT.  
Writing them may cause failure in the monitor.

#### (2) Sending and receiving binary format files (\*.G1□)

By using gateway common control (GS400.b8), binary format files (\*.G1□) can be read to a personal computer.

Note that reading of the following files is not allowed.

- \*.G1
- \*.G1D

For gateway common control (GS400), refer to the following.

- 6.4 ■ Specifying the file name to read
- 8.2 ■ Gateway function error information table

### ■ Reading GOT resource data with personal computer

Files stored in the GOT such as resource data can be read by operations from the personal computer (FTP client). This can be used for reading the resource data of multiple GOTs via Ethernet, for example.

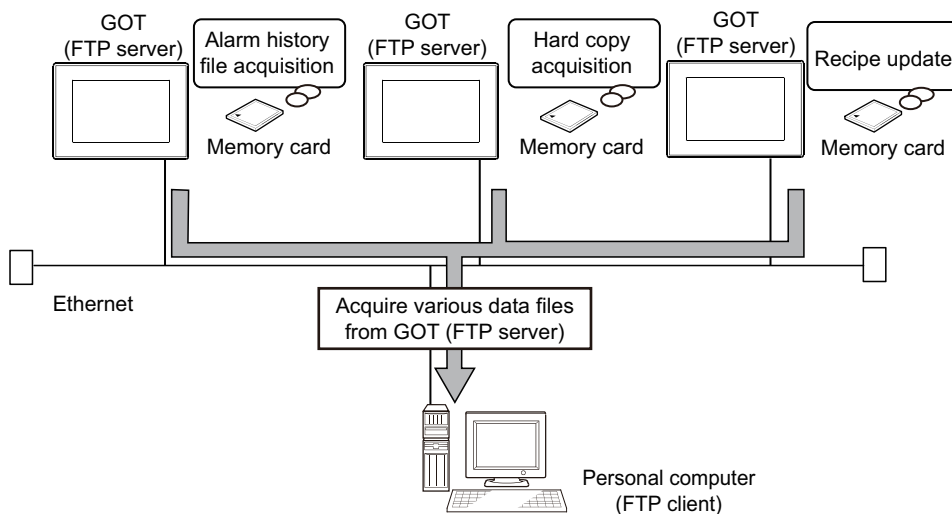

## ■ Sending files from the personal computer to the GOT

Files such as resource data can be written from the personal computer (FTP client) to the GOT (FTP server). This can be used for changing the resource data of multiple GOTs in a batch via Ethernet, for example.

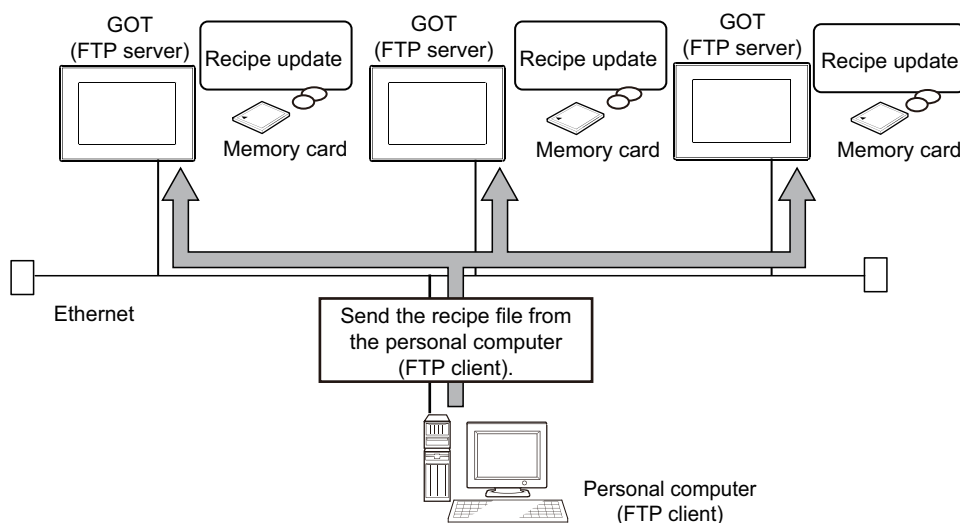

## ■ Connecting with multimedia interaction tool

With the multimedia interaction tool installed on the personal computer, the personal computer can receive video files or alarm log files sent from the GOT using the FTP server function.

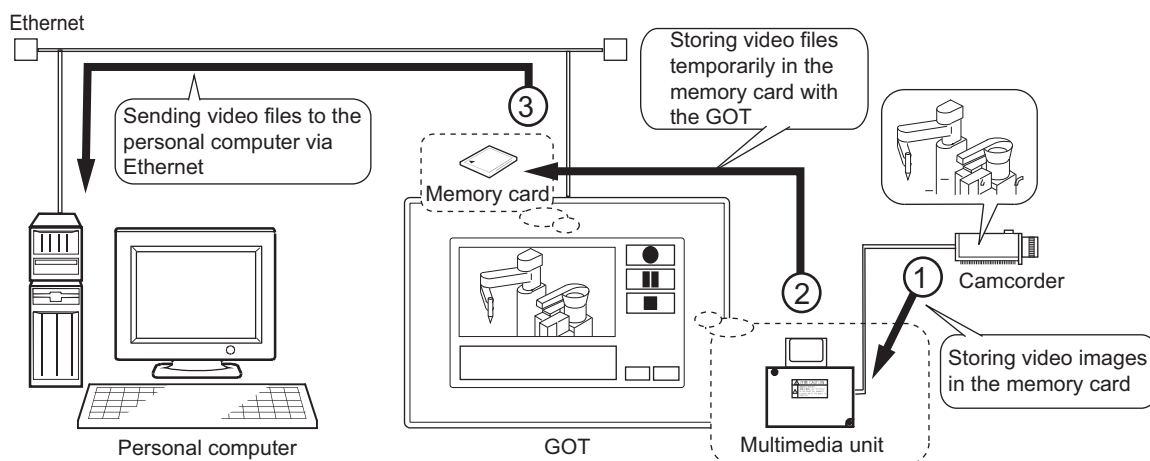

For details of the multimedia interaction tool, refer to the following manuals.

- For how to use the multimedia interaction tool

➔ GT Designer 3 Version1 Screen Design Manual (Functions)

- For connection with the multimedia interaction tool

➔ GOT1000 Series Connection Manual (Microcomputer, MODBUS Products, Peripherals) for GT Works3

## 1.4 Features of File Transfer Function (FTP Client)



The file transfer function (FTP client) uses the GOT as an FTP client, and writes files to an external FTP server. Files such as resource data can be written to the personal computer (FTP server) via Ethernet, by an operation from the GOT (FTP client).

Files can be written to the maximum of 16 FTP servers which have been registered in advance.

### ■ Sending files from the GOT to the FTP server

Various files such as resource data can be written into the personal computer (FTP server) by an operation from the GOT (FTP client).

This can be used to update the resource data inside the personal computer from the GOT.

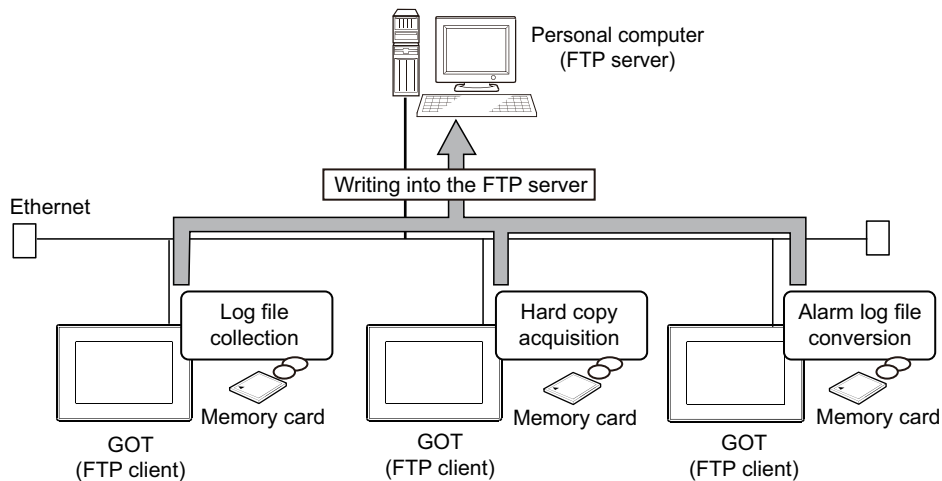

### ■ Acquiring resource data from the FTP server

Files such as resource data stored in the personal computer (FTP server) can be read by an operation from the GOT. This can be used to acquire the recipe file created with the personal computer to be used by the recipe function and to display image data saved in the personal computer on the GOT by the document display function.

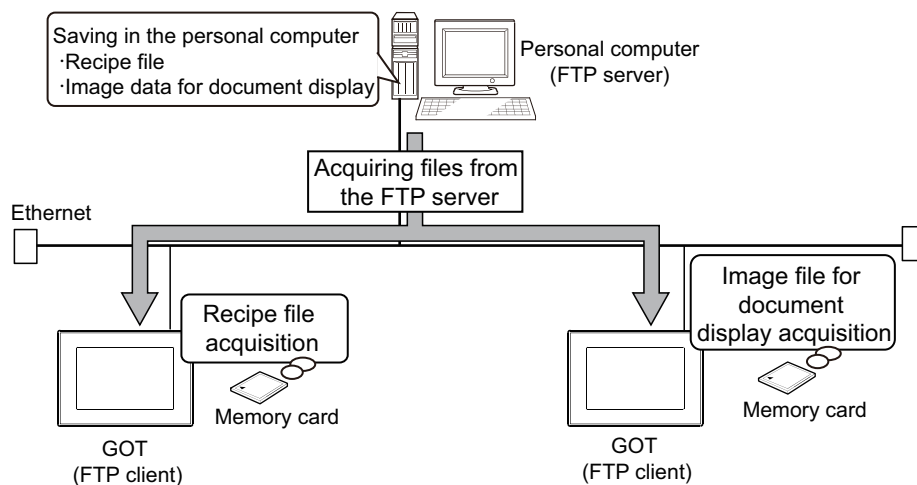







# 2. SYSTEM CONFIGURATION

This chapter describes the system configuration of the gateway system.

## 2.1 System Configuration of Gateway Functions

The system configuration differs according to the function to use.  
For the system configuration of each function, refer to the following.

- Client/server function  
 4.3 System Configuration
- Mail send function  
 5.2 System Configuration
- FTP server function  
 6.2 System Configuration
- File transfer function (FTP client)  
 7.2 System Configuration

### POINT

**(1) Available connections for the gateway function**

The gateway function cannot be used depending on connection type.  
Refer to the following manual for connection forms which is available / N/A for the gateway function.

 2.2 Types of Controller to GOT Connection

**(2) Data accessing method using the server/client function**

The server/client function allows the GOT (client) or personal computer (MX Component) to indirectly access the data (device) of the PLC or the GOT (client) by accessing the gateway device of the GOT (server).

## 2.2 Types of Controller to GOT Connection

GOTs that can use the server/client function are indicated below based on connection forms.

(Other gateway functions are not restricted by connection forms.)

Refer to the following manuals for information about the system configuration when using the server/client function.

 GOT1000 Series Connection Manual for GT Works3 and a controller used

○: Usable △: Usable under some restrictions ×: Unusable

Connection		GT16/GT15/GT14	GT12
MITSUBISHI PLC connection <sup>*5</sup>	Bus connection	○	×
	Direct CPU connection	○	×
	Computer link connection	○	×
	Ethernet connection	○	×
	MELSECNET/H connection (PLC to PLC network)	○	×
	MELSECNET/10 connection (PLC to PLC network)	△ <sup>*1</sup>	×
	CC-Link IE Controller Network connection	○	×
	CC-Link IE Field Network connection	○	×
	CC-Link connection (Intelligent device station)	△ <sup>*2*3</sup>	×
	CC-Link connection (Via G4)	○	×
Inverter connection		×	×
Servo amplifier connection		×	×
Robot controller connection <sup>*6</sup>		○	×
CNC connection <sup>*7</sup>	Serial connection	○	×
	Ethernet connection	○	×
	MELSECNET/10 connection (PLC to PLC network)	△ <sup>*1</sup>	×
	CC-Link connection (Intelligent device station)	△ <sup>*2</sup>	×
Third party PLC connection	Serial connection	△ <sup>*4</sup>	×
	Ethernet connection	○	×
Third party safety controller connection		○	×
Third party servo amplifier connection		×	×
Third party robot controller connection		×	×
Third party temperature controller connection		△ <sup>*4</sup>	×
Microcomputer connection	Serial connection	○	×
	Ethernet connection	○	×
MODBUS <sup>®</sup> /RTU connection		○	×
MODBUS <sup>®</sup> /TCP connection		○	×

\*1 When using the MELSECNET/10 connection, use a MELSECNET/H communication unit. The MELSECNET/10 communication unit is inapplicable.

\*2 When using the CC-Link communication, use a CC-Link communication unit (GT15-J61BT13). The CC-Link communication unit (GT15-75J61BR13-Z) is inapplicable.

\*3 The GT16 is applicable to the CC-Link (ID) Ver.2 only.

\*4 When connected to either of the following equipment, the server function and client function cannot be used.

▪ JTEKT PLC ▪ SHINKO indicating controller

\*5 Including connection to the motion controller CPU (Q series and A series), CNC C70, and CRnQ-700

\*6 Applicable to the CRnD-700 only. For the CRnQ-700, refer to the above Mitsubishi PLC connection.

\*7 Applicable to the MELDAS C6/C64 only. For the CNC C70, refer to the above Mitsubishi PLC connection.

**HINT**

**Examples of connections that do not allow the use of the gateway functions**

(Example 1) When using GT11

Since the Ethernet communication unit cannot be mounted, the gateway functions cannot be used.

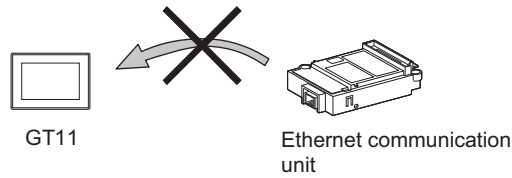

(Example 2) When using GT15

Since the CC-Link communication unit (GT15-75J61BR13-Z) cannot be mounted to a GOT together with the Ethernet communication unit, the gateway functions cannot be used.

When using CC-Link and Ethernet communication units together, use a CC-Link communication unit (GT15-J61BT13).

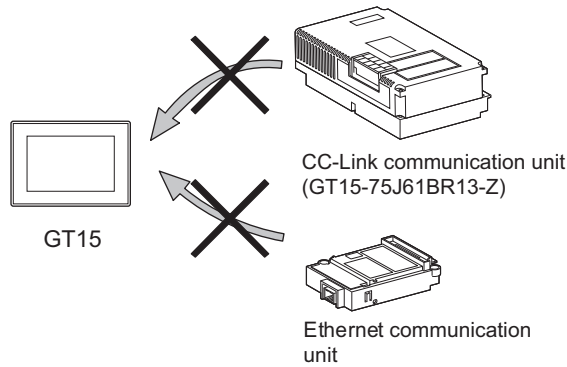

## 2.3 Communication Interface Setting

The following shows the communication interface settings for using the gateway function.

### POINT

#### Cases in which the communication interface setting is not required in the gateway function

When using Ethernet connection in the connection of such as PLCs, the gateway function communicates using the communication settings of such as PLCs.

When using the following drivers, the communication interface setting in the gateway function is not required.

- Ethernet(MELSEC), Q17nNC, CRnD-700
- Ethernet(MELSEC), Q17nNC, CRnD-700, Gateway
- MELSEC-FX(Ethernet)
- Ethernet(OMRON), Gateway
- Ethernet(KEYENCE), Gateway
- Ethernet(TOSHIBA nv), Gateway
- Ethernet(YASKAWA), Gateway
- Ethernet(YOKOGAWA), Gateway
- EtherNet/IP(AB), Gateway
- MODBUS/TCP, Gateway
- Ethernet(MICROCOMPUTER)

1. Select [Common] → [Controller Setting] from the menu to display the Controller Setting dialog box.
2. Select [Communication setting] and set the required items.

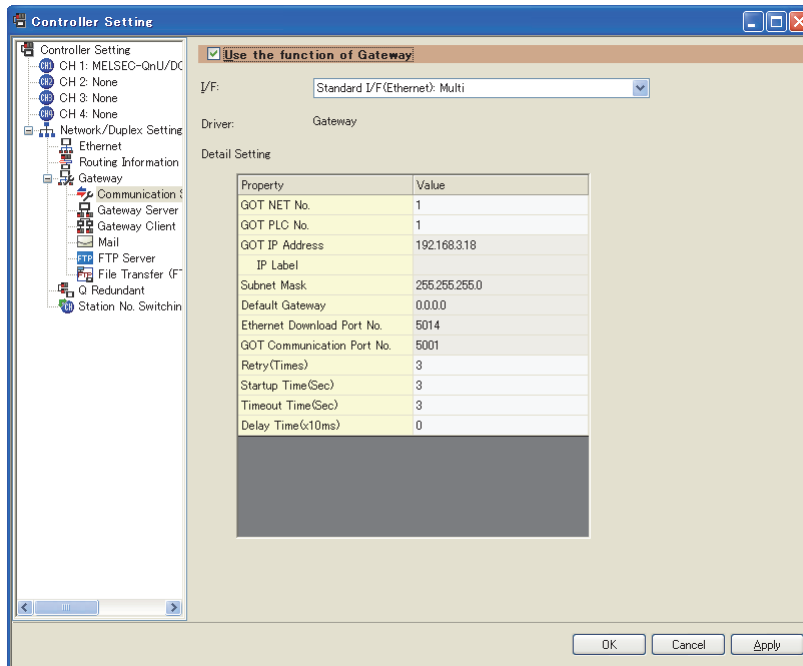

Item	Description
Use the function of Gateway	Check this item when using the gateway function.
I/F	Select the GOT communication interface to use in the gateway function.

(Continued to next page)

Item	Description	
Detail Setting	Set the details of the communication method.	
	GOT NET No.	Set the network No. of the GOT.
	GOT PLC No.	Set the station No. of the GOT.
	GOT IP Address	Set the IP address of the GOT.
	Subnet Mask	Set the subnet mask for the sub network. (Only for connection via router) If the sub network is not used, the default value is set. (Default: 255.255.255.0)
	Default Gateway	Set the router address of the default gateway where the GOT is connected. (Only for connection via router)
	Ethernet Download Port No.	Set the GOT port No. for Ethernet download.
	GOT Communication Port No.	Set the GOT port No. for the connection with the Ethernet module.
	Retry (Times)	Set the number of retries to be performed when a communication timeout occurs. When receiving no response after retries, the communication times out.
	Startup Time (Sec)	Specify the time period from the GOT startup until GOT starts the communication with the PLC CPU.
	Timeout Time (Sec)	Set the time period for a communication to time out.
Delay Time (x10ms)	Set the delay time for reducing the load of the network/destination PLC.	

1	OVERVIEW
2	SYSTEM CONFIGURATION
3	GENERAL PROCEDURE TO BE FOLLOWED FOR USING
4	SERVER AND CLIENT FUNCTIONS
5	MAIL SEND FUNCTION
6	FTP SERVER FUNCTION
7	FILE TRANSFER FUNCTION (FTP CLIENT)
8	TROUBLE SHOOTING

## 2.4 Precautions for System Configuration

---

### ■ Connection to the intranet

To secure the safety of the system against illegal access when connecting the system to the intranet, consult the network access provider or network administrator (person who does network planning, IP address management, etc.).

We have no liability for any system problems that occur at the time of connection to the intranet.

### ■ Access delay measures

Connection of multiple pieces of network equipment (including GOTs) to the same segment may degrade the performance of communications between a GOT and a PLC CPU due to increased network load.

Communication performance may be improved by taking the measures below.

- Using a switching hub
- Decreasing the number of device monitored by the GOT

### ■ Use of firewalls

If the firewall shuts off communication of the gateway function, it is necessary to change the port No. of the firewall.

To secure the safety of the system against illegal access when changing the port No. of the firewall, consult the network access provider or network administrator (person who does network planning, IP address management, etc.).

We have no liability for any system problems that occur at the time of changing the port No.

# 3. GENERAL PROCEDURE TO BE FOLLOWED FOR USING

This chapter describes the general procedure to be followed for using the gateway functions.

1. Examine the configuration of the whole system.
  - Connection structure of the whole system such as the controllers and GOTs
  - Controller setting (device assignment, etc.)
  - GOT setting (IP address, network number, station number, etc.)
2. Connect GOT and controllers.

 GOT1000 Series Connection Manual for GT Works3 and a controller used

3. Establish a system for the gateway function to be used.

Function	Reference
Server/client function	4.3
Mail send function	5.2
FTP server function	6.2
File transfer function (FTP client)	7.2

4. Set the communication interface.

 2.3 Communication Interface Setting

5. Set the gateway functions to be used.

Function	Setting	Reference
Server/client function	Make server and client settings on GT Designer3.	4.4
Mail send function	Set the mail of each object on GT Designer3.	5.3
	Set the send destination and SMTP server in the mail send setting.	
FTP server function	Configure the FTP server setting with GT Designer3.	6.3
File transfer function (FTP client)	Configure the connected FTP server setting with GT Designer3.	7.3
	Configure the file transfer setting with GT Designer3.	

6. Prepare the project data.

 GT Designer 3 Version1 Screen Design Manual (Fundamentals)  
GT Designer 3 Version1 Screen Design Manual (Functions)

7. Debug the project data by operating the GOT.





# 4. SERVER AND CLIENT FUNCTIONS



This chapter describes the server and client functions.

Before using the example programs described in this chapter in an actual system, please verify that the program has no problems in the control of the target system.

## 4.1 Gateway Devices

### 4.1.1 What are the gateway devices?

The gateway devices are virtual devices designed exclusively to perform the server and client functions on a GOT. They are used by assigning the controller devices and the internal devices of a GOT.

#### ■ When accessing PLCs from a personal computer via a GOT

A personal computer can indirectly access the controller devices by accessing the gateway devices of GOTs (server).

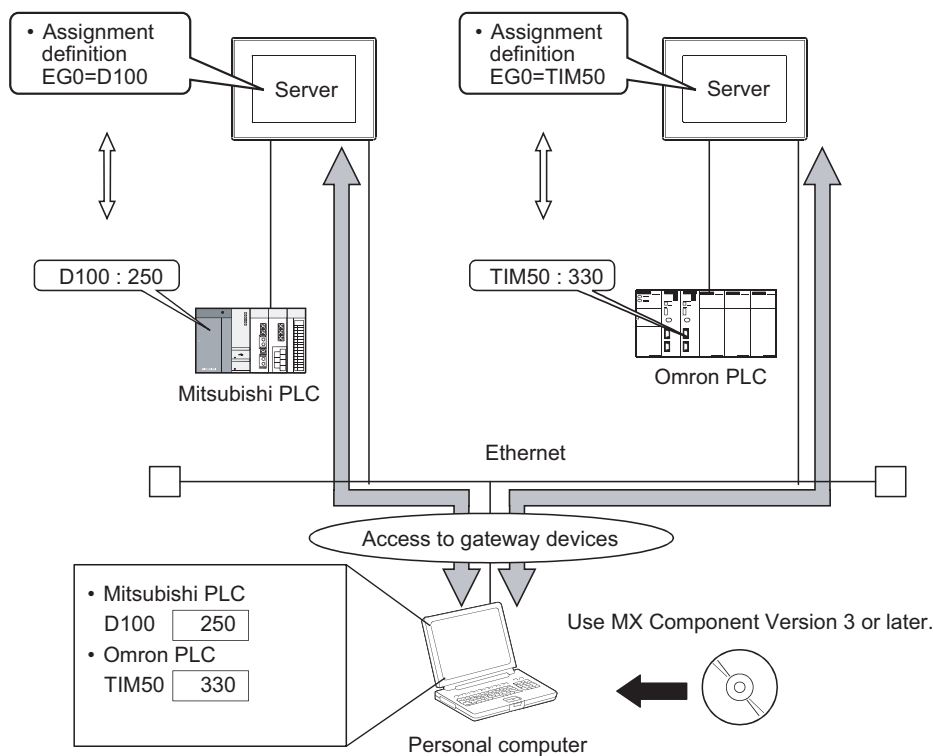

## ■ When monitoring PLCs of difference makers from one GOT

A GOT (client) can indirectly access the controller devices by accessing the gateway devices of a GOT (server).

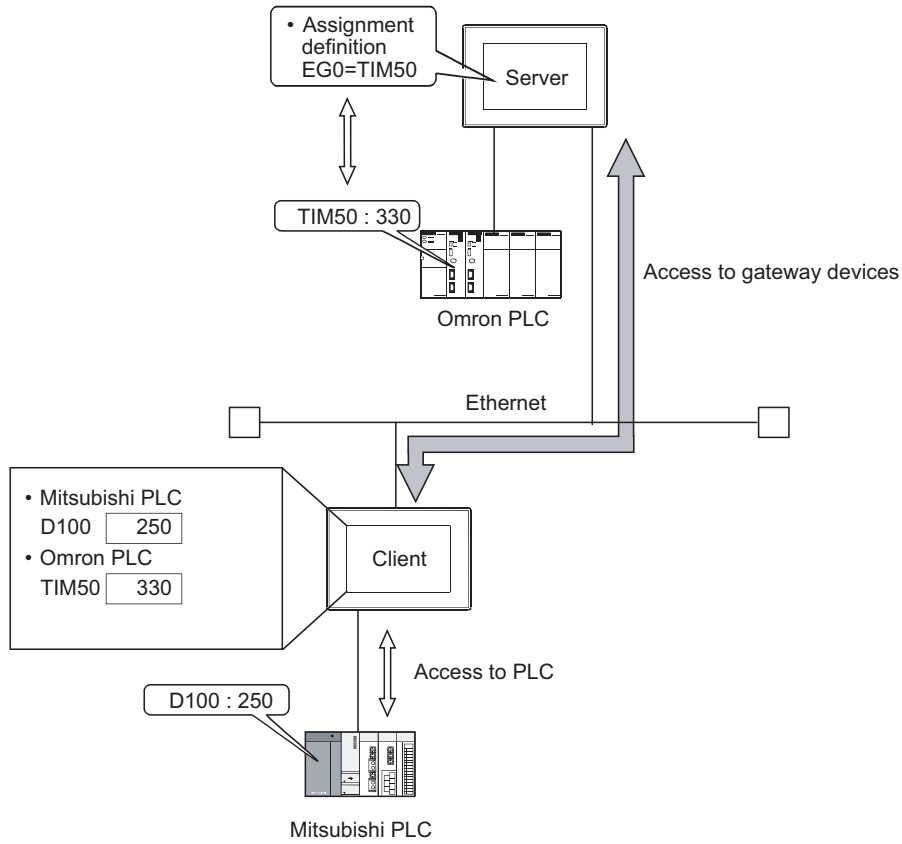

### 4.1.2 Usable gateway devices

The usable gateway devices are indicated below:

Device Name		Device Range	Device Number Representation
Word device	EG	EG0 to EG32767	Decimal
Bit device	EG	Specified bits of word devices indicated above	Decimal

### 4.1.3 How to monitor the gateway devices

#### ■ When accessing gateway devices from a personal computer

Access gateway devices of a GOT using the functions of MX Component.

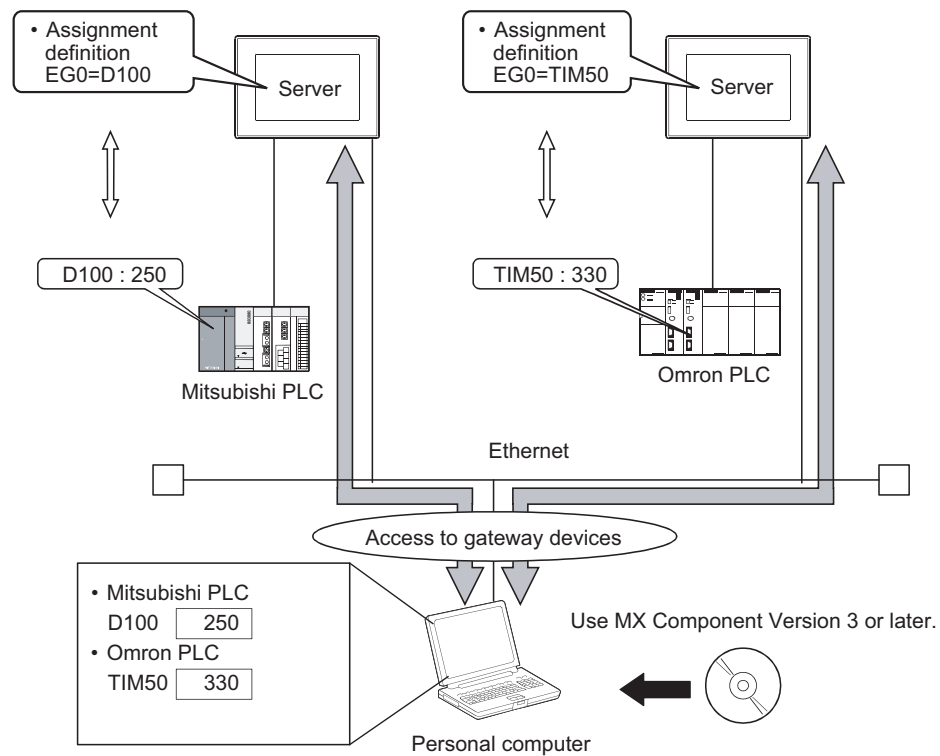

Refer to the following manuals for the operation method and programming procedure of the MX Component.

- ☞ MX Component Version 3 Operating Manual
- MX Component Version 3 Programming Manual

The table below shows the MX Component functions that are compatible with the GOT:

Item	Description
Open	Opens the communication line (starts communication with the GOT).
Close	Closes the communication line (ends communication with the GOT).
ReadDeviceBlock	Batch-reads data from devices.
ReadDeviceBlock2	
WriteDeviceBlock	Batch-writes data to devices.
WriteDeviceBlock2	
ReadDeviceRandom	Randomly reads data from devices.
ReadDeviceRandom2	
WriteDeviceRandom	Randomly writes data to devices.
WriteDeviceRandom2	
EntryDeviceStatus	Registers device status watching.
FreeDeviceStatus	Cancels registering device status watching.
OnDeviceStatus	Announces event.
SetDevice	Changes the device data values.
SetDevice2	
GetDevice	Gets the device data values.
GetDevice2	
GetCpuType	Gets the GOT model.

## ■ When accessing gateway devices from the GOT

Gateway devices cannot be assigned to the object functions.  
For this reason, use Project script and Screen script to monitor.  
Object script cannot be used.

The following explains the setting example for accessing gateway devices from a GOT.

### (1) When reading a gateway device value

Read the value of a gateway device of the GOT (server) to an internal device of the GOT (client) using the script function.

By monitoring the value read to the internal device using the numerical value display function or the like, the GOT (client) can monitor the same value as the gateway device value of the GOT (server).

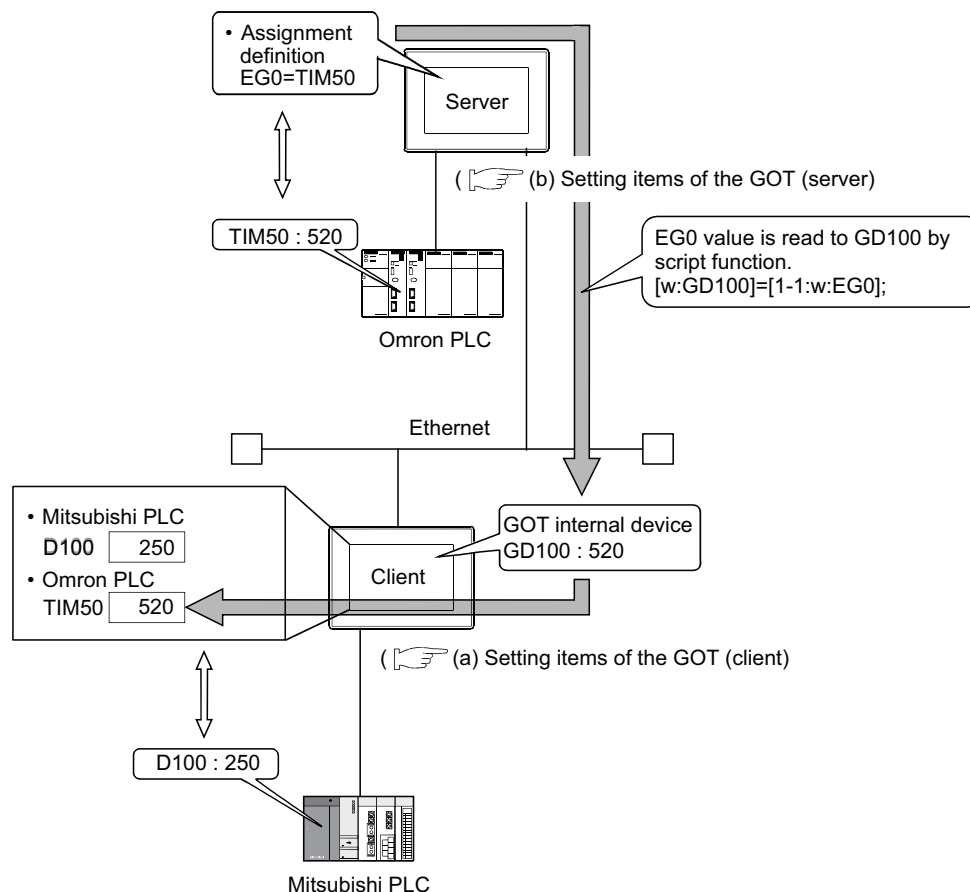

## HINT

### Read destination of the script function

A device of Mitsubishi Electric PLC CPU may be specified as the destination for reading out a value by the script function.

- (a) Setting items of the GOT (client)
  - Script function.....Make setting to read the gateway device value of the GOT (server) to the internal device of the GOT (client).
  - Client setting.....Register the GOT (server) whose device value should be read.
  - Numerical display 1 function...Make setting to display the device value of a Mitsubishi Electric PLC CPU.
  - Numerical display 2 function...Make setting to display the internal device value of the GOT (client).
- (b) Setting items of the GOT (server)
  - Server setting.....Make setting to assign a device of Omron PLC to a gateway device.

## (2) When writing a value to the gateway device

Use numerical input function or the like to write a value to the internal device of the GOT (client).

Use the script function to write the value of the internal device of the GOT (client) to the gateway device of the GOT (server).

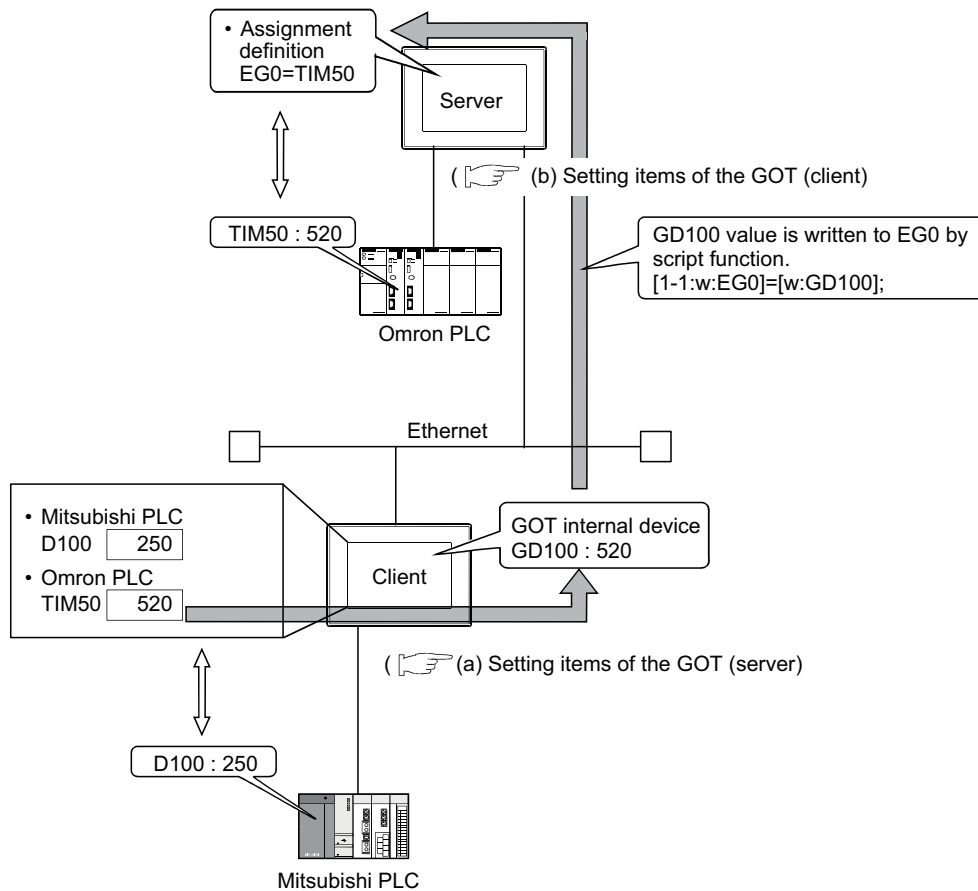

### Destination of writing by the script function

An internal device of the GOT (server) may be specified as the destination of writing by the script function.

- (a) Setting items of the GOT (client)
  - Script function.....Make setting to write the internal device value of the GOT (client) to the gateway device of the GOT (server).
  - Client setting.....Register the GOT (server) where the value will be written.
  - Numerical input 1 function...Make setting to input a value to the device of Mitsubishi Electric PLC CPU.
  - Numerical input 2 function...Make setting to input a value to the internal device of the GOT (client).
- (b) Setting items of the GOT (server)
  - Server setting.....Make setting to assign a device of Omron PLC to a gateway device.



### Details about the script function

Refer to the following manual for details of the script function.

GT Designer 3 Version1 Screen Design Manual (Functions)

For examples of using the script function, refer to Section 4.4 of this manual.

## 4.1.4 Controller devices that can be assigned

### ■ Controller devices that can be assigned

The controller devices that can be monitored by a GOT and the GOT internal devices can be assigned to the gateway devices.

Refer to the following manual for the devices that can be monitored by a GOT.

 GT Designer 3 Version1 Screen Design Manual (Fundamentals)

### ■ Precautions for monitoring the gateway devices

When the following controller devices are assigned to the gateway devices, there are cases monitoring is not possible depending on the used script function commands or MX Component functions.

To monitor such unusable devices, change them to other devices of the controller and access those devices from a GOT.

The restricted commands / functions are indicated below by controller models:

○: No restrictions △: Some devices cannot be used (unusable device names are indicated in parentheses) ×: Cannot be used

Controller		Restricted Script Function Commands			Restricted MX Component Functions		
		bmov, fmov instruction	Device specified as word	Device specified as bit	Read Device Block	Read Device Random Write Device Random	
						Device specified as word	Device specified as bit
Mitsubishi Electric	Q/L/QnACPU, CRnD-700	△ (TT, TC, CT, CC, SC, SS)	△ (TT, TC, CT, CC, SC, SS)	△ (TN, CN, SN, Z, BM)	△ (TT, TC, CT, CC, SC, SS)	△ (TT, TC, CT, CC, SC, SS)	△ (TN, CN, SN, Z, BM)
	ACPU	△ (TT, TC, CT, CC)	△ (TT, TC, CT, CC)	△ (Z, V, BM)	△ (TT, TC, CT, CC)	△ (TT, TC, CT, CC)	△ (Z, V, BM)
	FXCPU	△ (TC, CS)	△ (T, C)	△ (TC, CS)	△ (TS, CS)	△ (T, C)	△ (TS, CS)
	WSCPU	△ (I, Q, LQ, LI)	○	△ (I, Q, LQ, LI)	△ (I, Q, LQ, LI)	○	△ (I, Q, LQ, LI)
	CNC	△ (TN, CN, SN, Z, BN)	△ (TT, TC, CT, CC, SC, SS)	△ (TN, CN, SN, Z, BN)	△ (TN, CN, SN, Z, BN)	△ (TT, TC, CT, CC, SC, SS)	△ (TN, CN, SN, Z, BN)
OMRON PLC		○	○	○	○	○	○
OMRON temperature controller		△ (A, C0, C1, C3)	×	△ (A, C0, C1, C3)	△ (A, C0, C1, C3)	×	△ (A, C0, C1, C3)
KEYENCE PLC		△ (VB, T, C, CTC, TC, TS, CC, CS, CTH, CTC, DZ, TRM)	△ (..., MR, LR, CR, B, VB, T, C, TC, TS, CC, CS, CTH, CTC, CM, TM, VM, Z, DZ, TRM)	△ (T, C, CTC, TC, TS, CC, CS, CTH, CTC, CM, TM, VM, Z, DZ, TRM)	△ (VB, T, C, CTC, TC, TS, CC, CS, CTH, CTC, DZ, TRM)	△ (..., MR, LR, CR, B, VB, T, C, TC, TS, CC, CS, CTH, CTC, DZ, TRM)	△ (T, C, CTC, TC, TS, CC, CS, CTH, CTC, CM, TM, VM, Z, DZ, TRM)
KOYO EI PLC		○	○	×	○	○	×
JTEKT PLC		△ (TCS)	△ (TCS)	△ (EB, TCS)	△ (TCS)	△ (TCS)	△ (EB, TCS)
SHARP PLC		△ <sup>*1</sup> (T, C)	△ (T, C)	△ (T, C)	△ <sup>*1</sup> (T, C)	△ (T, C)	△ (T, C)
SHINKO indicating controller		×	×	×	×	×	×
CHINO controller		○	△ (0, 1)	○	○	△ (0, 1)	○
TOSHIBA PLC	Unified Controller nv	○	×	△ (XW, YW, RW, SW, IW, QW)	○	×	△ (XW, YW, RW, SW, IW, QW)
	PROSEC TV	○	△ (Z, T, C)	○	○	△ (Z, T, C)	○

(Continued to next page)

Controller	Restricted Script Function Commands			Restricted MX Component Functions		
	bmov, fmov instruction	Device specified as word	Device specified as bit	Read Device Block	Read Device Random Write Device Random	
					Device specified as word	Device specified as bit
TOSHIBA MACHINE PLC	○	△ (X, I, Y, O, R, GR, H, J, K, T, C, S, L, E, A)	△ (XW, IW, YW, OW, RW, GW, HW, JW, KW, TW, CW, SW, LW, EW, AW, D, B, U, M, Q, P, V)	○	△ (X, I, Y, O, R, GR, H, J, K, T, C, S, L, E, A)	△ (XW, IW, YW, OW, RW, GW, HW, JW, KW, TW, CW, SW, LW, EW, AW, D, B, U, M, Q, P, V)
PANASONIC INDUSTRIAL DEVICES SUNX PLC	○	△ (T, C)	○	○	△ (T, C)	○
HITACHI IES PLC	○	△ (X, Y, L, L1, M, D, SS, WDT, MS, TMR, CU, RCU, CT, R, DIF, DFN)	○	○	△ (X, Y, L, L1, M, D, SS, WDT, MS, TMR, CU, RCU, CT, R, DIF, DFN)	○
HITACHI PLC	△ (LLL, LML, LF, LG)	△ (X, Y, R, M, A, K, T, U, C, GL, E, S, J, Q, LLL, LML, LF, LG)	△ (XW, YW, RW, MW, AW, KW, TW, UW, CW, GW, EW, SW, JW, QW, TC, TS, UC, US, CC, CS, LLL, LML, LF, LG)	△ (LLL, LML, LF, LG)	△ (X, Y, R, M, A, K, T, U, C, GL, E, S, J, Q, LLL, LML, LF, LG)	△ (XW, YW, RW, MW, AW, KW, TW, UW, CW, GW, EW, SW, JW, QW, TC, TS, UC, US, CC, CS, LLL, LML, LF, LG)
FUJI PLC	△ (BD, TS, TR, W9, CS, CR)	△ (B, M, K, F, A, D, L, T, C, BD, TS, TR, W9, CS, CR)	△ (WB, WM, WK, WF, WA, WD, WL, BD, TS, TR, W9, CS, CR)	△ (BD, TS, TR, W9, CS, CR)	△ (B, M, K, F, A, D, L, T, C, BD, TS, TR, W9, CS, CR)	△ (WB, WM, WK, WF, WA, WD, WL, BD, TS, TR, W9, CS, CR)
FUJI temperature controller	○	△ (0, 1)	○	○	△ (0, 1)	○
MATSUSHITA PLC	○	△ (T, C)	○	○	△ (T, C)	○
YASKAWA PLC	○	○	○	○	○	○
AZBIL control equipment	SDC/DMC	○	○	○	○	○
	DMC50	×	×	×	×	×
YOKOGAWA PLC	△ (M, Z)	△ (M, TU, CU, Z)	△ (M, TP, TS, CP, CS, Z)	△ (M, Z)	△ (M, TU, CU, Z)	△ (M, TP, TS, CP, CS, Z)
YOKOGAWA PLC (MODBUS®/TCP connection)	△ (6)	△ (0, 1)	△ (6)	△ (6)	△ (0, 1)	△ (6)
YOKOGAWA temperature controller	○	○	○	○	○	○
RKC temperature controller	○	△ (0, 1)	○	○	△ (0, 1)	○

(Continued to next page)



Controller		Restricted Script Function Commands			Restricted MX Component Functions		
		bmov, fmov instruction	Device specified as word	Device specified as bit	Read Device Block	Read Device Random Write Device Random	
						Device specified as word	Device specified as bit
ALLEN-BRADLEY PLC	SLC500	△ (T, C)	△ (T, C)	△ (T, C)	△ (T, C)	△ (T, C)	△ (T, C)
	MicroLogix 1000/1200/1500 series	△ (T, C, L)	△ (T, C, L)	△ (T, C, L)	△ (T, C, L)	△ (T, C, L)	△ (T, C, L)
	Control/CompactLogix	△ (DINT, REAL)	△ (BOOL, DINT, REAL)	△ (DINT, REAL)	△ (DINT, REAL)	△ (BOOL, DINT, REAL)	△ (DINT, REAL)
GE PLC		○	○	△ (I, Q, M, T, S, SA, SB, SC, G)	○	○	△ (I, Q, M, T, S, SA, SB, SC, G)
SICK Safety Controller		△ (I, Q, LQ, LI)	○	△ (I, Q, LQ, LI)	△ (I, Q, LQ, LI)	○	△ (I, Q, LQ, LI)
SIEMENS PLC	S7-300/400 series	○	△ (I, Q, M)	△ (IW, QW, MW)	○	△ (I, Q, M)	△ (IW, QW, MW)
	S7-200 series	△ (T, C, HC)	△ (V, I, Q, M, SM, T, C, S, HC)	△ (VW, IW, QW, AIW, AQW, MW, SMW, T, C, SW, HC)	△ (T, C, HC)	△ (V, I, Q, M, SM, T, C, S, HC)	△ (VW, IW, QW, AIW, AQW, MW, SMW, T, C, SW, HC)
SCHNEIDER PLC (MODBUS®/TCP connection)		△ (6)	△ (0, 1)	△ (6)	△ (6)	△ (0, 1)	△ (6)
Microcomputer		○	○	○	○	○	○
MODBUS equipment (MODBUS®/RTU connection, MODBUS®/TCP connection)		△ (6)	△ (0, 1)	△ (6)	△ (6)	△ (0, 1)	△ (6)

\*1 For registers (09 to E7) and file registers (1 to 7), do not make a setting that spans two blocks. Otherwise monitoring will be disabled.

(Example) When the bmov instruction is used with the script function  
The gateway device to which TT (ALLEN-BRADLEY PLC device) is assigned cannot be monitored.

- The devices not indicated in the table in the previous page can be monitored.
- Monitoring is possible with the commands specified a device as a bit.

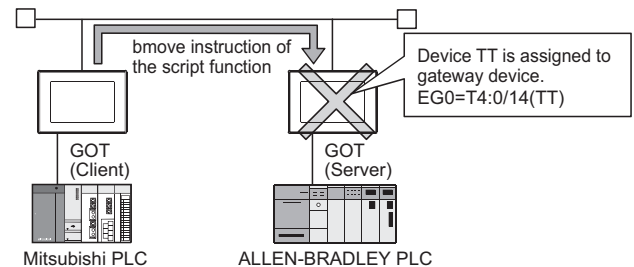

## HINT

### Restricted script function commands

The commands specified a device as a word or bit device may not be executed correctly with a wrong device specified.

When a gateway device is used, write the script correctly so that designation of the device is correct.

Commands specified a device as a word or bit device are indicated below:

- Commands specified a device as a word

Item	Description	
Function	Applied arithmetic operation	sin, cos, tan, asin, acos, atan, abs, log, log10, exp, ldexp, sqrt

- Commands specified a device as a bit

Item	Description	
Operator	Bit device	&,  , ~, ^, <<, >>
	Substitution	=
	Device operation	set, rst, alt

Refer to the following manual for details of commands.

GT Designer 3 Version1 Screen Design Manual (Functions)

## 4.2 Specifications

### 4.2.1 Specifications

The specifications of the server and client functions are given below:

Item		Specifications	Setting Method
Port number	Server function	5011	Fixed
	Client function	5012, 5013	
Max. number of nodes		Recommended: Total number of the following nodes is 64. <ul style="list-style-type: none"> <li>• GOT (server)</li> <li>• GOT (client)</li> <li>• Personal computer that communicates with a GOT</li> </ul>	–
Number of clients (GOT, personal computer) that can access a server (GOT) simultaneously		Max. 5 units*1	–
Other node designation		IP address designation, max. 128 nodes	GT Designer2
Gateway device		32768 points of word devices: EG0 to 32767	
Compatible MX Component		MX Component Version 3 or later	–
Memory space used by GOT (bytes)	Server function	$20 + 20 \times (\text{Number of assigned gateway devices})$	GT Designer2
	Client function	$16 + 20 \times (\text{Preset number of GOTs (server)})$	

\*1 If six or more clients (GOT, personal computer) make simultaneous access to the server (GOT), processing of the script at a client may stop.

### 4.2.2 Access range that can be monitored

When the monitoring of a controller is required via a GOT, it is possible by monitoring controller devices that are assigned to gateway devices. (The devices of the controller on the network can be monitored by assigning the devices to gateway devices.)

The access range that can be monitored is the same the GOT does.

Refer to the following manual for the range that a GOT can monitor.

 GOT1000 Series Connection Manual (Mitsubishi Products) for GT Works3

The accessible range of a PLC CPU from a GOT 1) (client) or a personal computer (MX Component) is indicated below:

■ **When GOT 2) (server) and a PLC 1) are connected in the direct CPU connection or computer link connection**

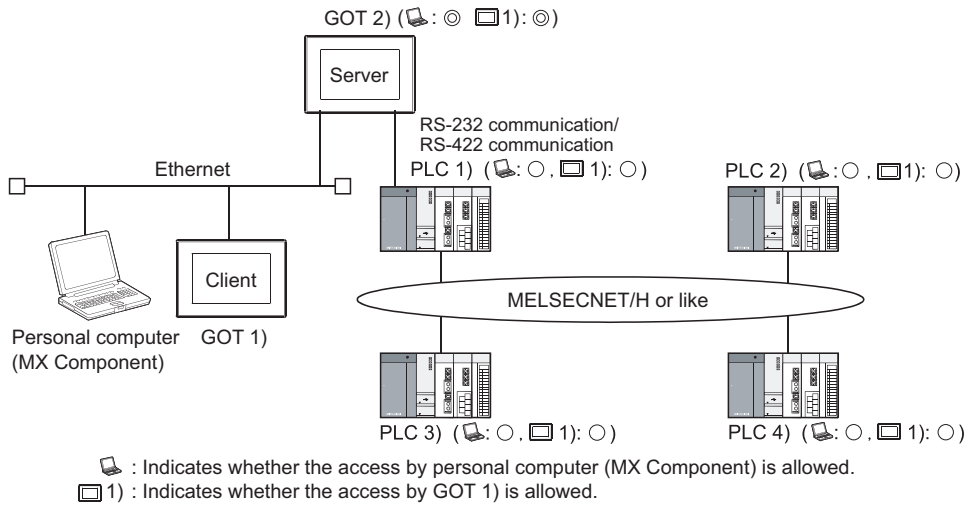

Access Source	Access Destination	
	GOT 2) (server)	PLC 1), PLC 2), PLC 3), PLC 4)
Personal computer (MX Component), GOT 1) (client)	☹	○

☹ : Can monitor a gateway device or a controller device from a personal computer (MX Component) or a GOT 1) (client).  
 ○ : Can monitor a controller device that is assigned to a gateway device of GOT 2) from a personal computer (MX Component) or a GOT 1) (client).

■ **When GOT 2) (server) and a PLC are connected in the CC-Link connection (via G4)**

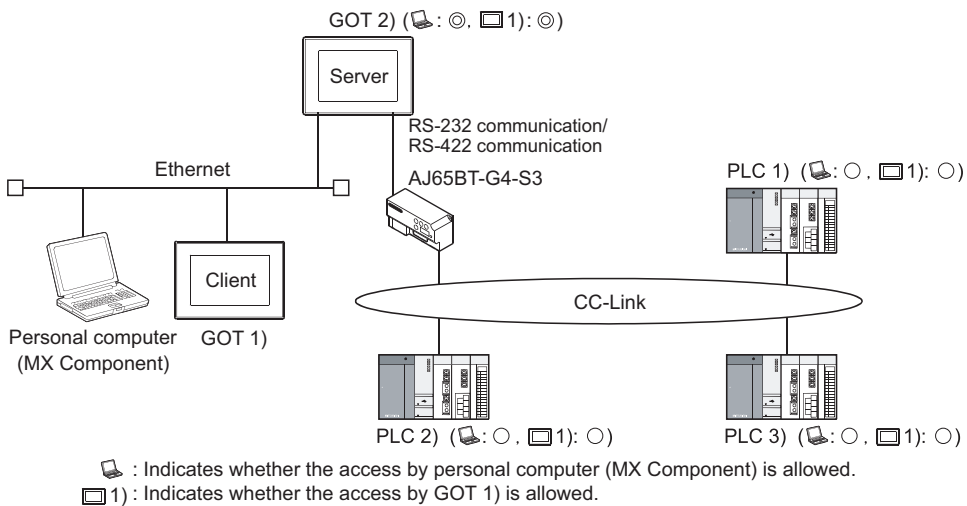

Access Source	Access Destination	
	GOT 2) (server)	PLC 1), PLC 2), PLC 3)
Computer (MX Component), GOT 1) (client)	☹	○

☹ : Can monitor a gateway device or a controller device from a personal computer (MX Component) or a GOT 1) (client).  
 ○ : Can monitor a controller device that is assigned to a gateway device of GOT 2) from a personal computer (MX Component) or a GOT 1) (client).

1 OVERVIEW  
 2 SYSTEM CONFIGURATION  
 3 GENERAL PROCEDURE TO BE FOLLOWED FOR USING  
 4 SERVER AND CLIENT FUNCTIONS  
 5 MAIL SEND FUNCTION  
 6 FTP SERVER FUNCTION  
 7 FILE TRANSFER FUNCTION (FTP CLIENT)  
 8 TROUBLE SHOOTING

## ■ When GOT 2) (server) and a PLC are connected in the Ethernet connection

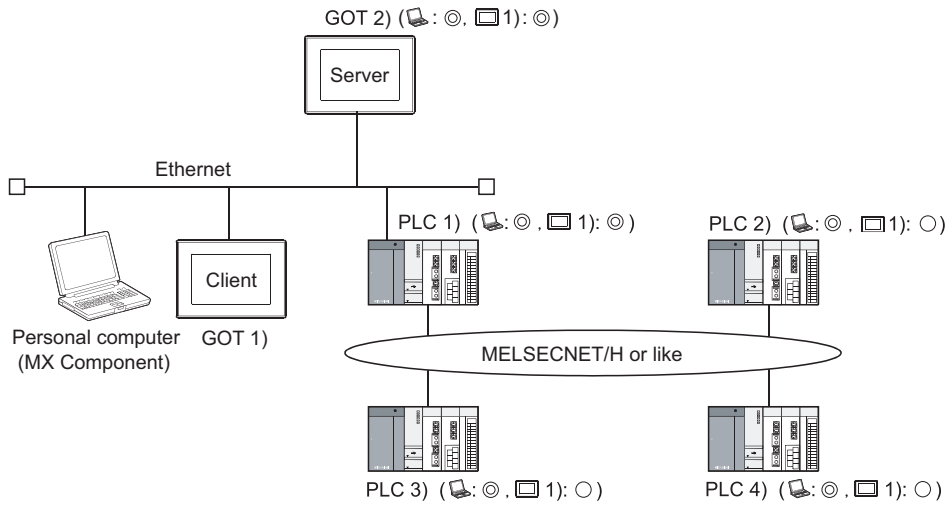

🖥️ : Indicates whether the access by personal computer (MX Component) is allowed.  
 🏠1) : Indicates whether the access by GOT 1) is allowed.

Access Source	Access Destination		
	GOT 2) (server)	PLC 1)	PLC 2), PLC 3), PLC 4)
Personal computer (MX Component)			◎
GOT 1) (client)	◎		○

◎ : Can monitor a gateway device or a controller device from a personal computer (MX Component) or a GOT 1) (client).  
 ○ : Can monitor a controller device that is assigned to a gateway device of GOT 2) from a personal computer (MX Component) or a GOT 1) (client).

## ■ When GOT 2) (server) and a PLC/Temperature controller are connected in the third party PLC connection

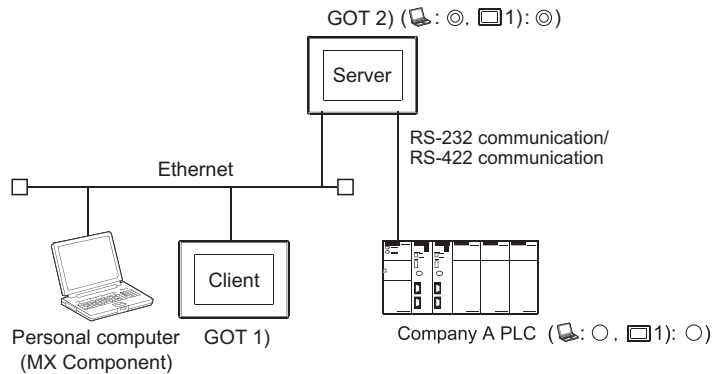

🖥️ : Indicates whether the access by personal computer (MX Component) is allowed.  
 🏠1) : Indicates whether the access by GOT 1) is allowed.

Access Source	Access Destination	
	GOT 2) (server)	PLC/Temperature controller
Personal Computer (MX Component), GOT 1) (client)	◎	○

◎ : Can monitor a gateway device or a controller device from a personal computer (MX Component) or a GOT 1) (client).  
 ○ : Can monitor a controller device that is assigned to a gateway device of GOT 2) from a personal computer (MX Component) or a GOT 1) (client).

# 4.3 System Configuration

This section explains the system configuration of the server/client function.

## ■ Connection with GOT (client)

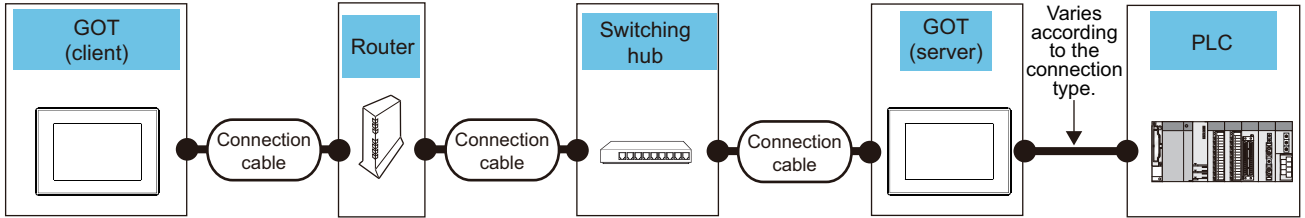

GOT (client)			Connection cable	Router* <sup>2</sup>	Switching hub	GOT (server)		
OS	Option device	Model* <sup>4</sup>				OS	Option device	Model* <sup>4</sup>
Option OS (Gateway (Server, Client))	- (Built into GOT)		Shielded twisted pair cable (STP) Category 5	A router that meets the IEEE802.3 100BaseTX standard.* <sup>1</sup>	A switching hub that meets the IEEE802.3 100BaseTX standard.* <sup>1</sup>	Option OS (Gateway (Server, Client))	- (Built into GOT)	
	GT15-J71E71-100							
	Option function board* <sup>3</sup>							

- \*<sup>1</sup> When using routers or switching hubs with security settings available, enable the communication with the port No. to be used.
- \*<sup>2</sup> A router is required only when connecting to a GOT (client) on another network.
- \*<sup>3</sup> Use the following option function board.

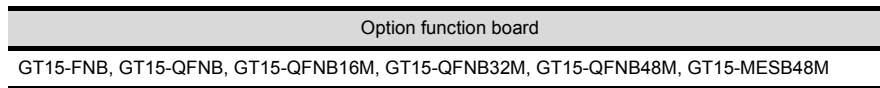

- \*<sup>4</sup> For GT14, only GT1455-QTBDE and GT1450-QLBDE can be used.

## ■ Connection with personal computer (MX Component)

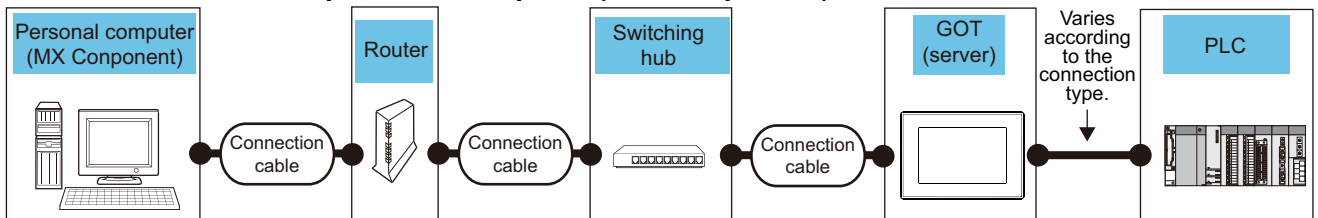

Personal computer (MX Component)	Connection cable	Router* <sup>2</sup>	Switching hub	GOT (server)		
				OS	Option device	Model* <sup>4</sup>
Personal computer in which MX Component is installed	Shielded twisted pair cable (STP) Category 5	A router that meets the IEEE802.3 100BaseTX standard.* <sup>1</sup>	A switching hub that meets the IEEE802.3 100BaseTX standard.* <sup>1</sup>	Option OS (Gateway (Server, Client))	- (Built into GOT)	
					GT15-J71E71-100	
					Option function board* <sup>3</sup>	

- \*<sup>1</sup> When using switching hubs with security settings available, enable the communication with the port No. to be used.
- \*<sup>2</sup> A router is required only when connecting to a personal computer (MX Component) on another network.
- \*<sup>3</sup> Use the following option function board.

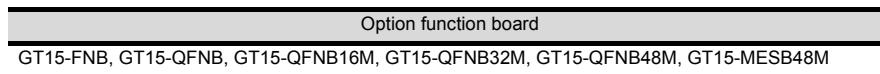

- \*<sup>4</sup> For GT14, only GT1455-QTBDE and GT1450-QLBDE can be used.

### POINT

#### Communication interface setting

For the communication interface setting, refer to the following.

➡ 2.2 Types of Controller to GOT Connection

1 OVERVIEW  
 2 SYSTEM CONFIGURATION  
 3 GENERAL PROCEDURE TO BE FOLLOWED FOR USING  
 4 SERVER AND CLIENT FUNCTIONS  
 5 MAIL SEND FUNCTION  
 6 FTP SERVER FUNCTION  
 7 FILE TRANSFER FUNCTION (FTP CLIENT)  
 8 TROUBLE SHOOTING

## 4.4 Setting Method

To use the server function, perform server setting (☞ ■Server setting in this section).

To use the client function, perform client setting (☞ ■Client setting in this section).

### ■ Server setting

In the server setting, set the gateway device to be used by the GOT (server) and the controller device to be assigned to that gateway device.

#### (1) Server function setting method

1. Select [Common] → [Controller Setting] from the menu to display the Controller Setting dialog box.
2. Select [Gateway Server] and set the required items.

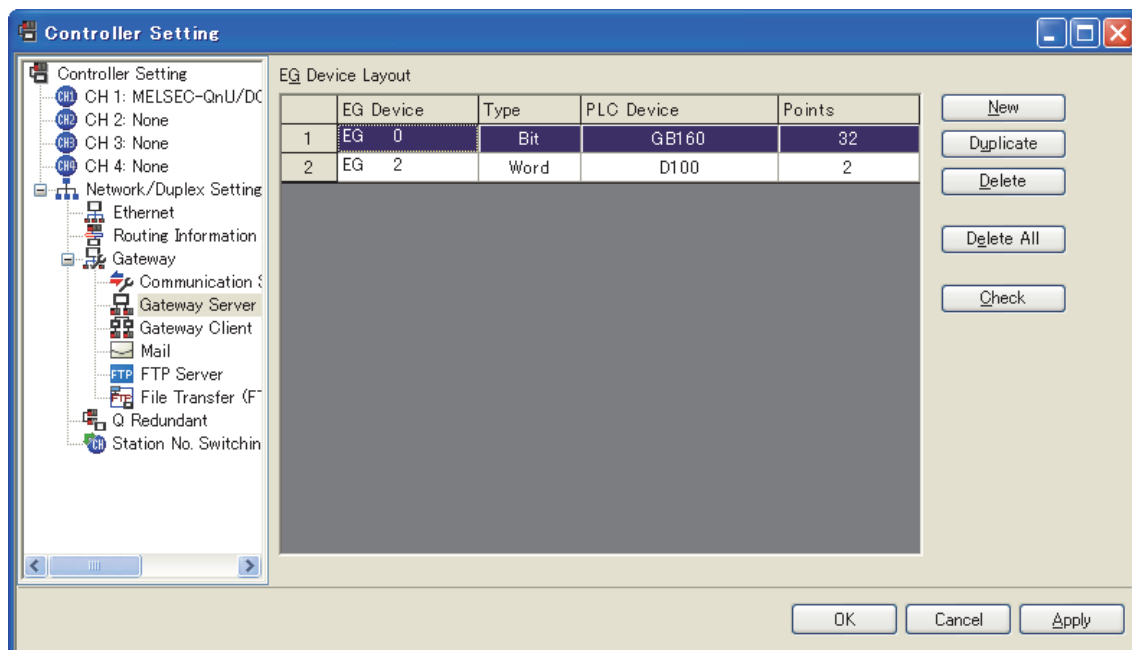

Item	Description
Assignment setting table	The table sets the assignment between the gateway devices and the PLC CPU devices.
EG Device	Set the gateway device.
Type	Select the type of the device to be assigned.
PLC Device	Set the controller device to be assigned to the gateway device. Refer to the following for the device setting method. ☞ GT Designer 3 Version1 Screen Design Manual (Fundamentals)
Points	Set the number of points of the device to be assigned. Setting is impossible for the number of points that cannot be assigned. ☞ ■Server setting (2) Precautions for device assignment in this section)
New	Used to add new assignment setting.
Duplicate	Used to add a copy of the selected assignment settings.
Delete	Used to delete the selected assignment.
Delete All	Used to delete all settings.
Check	Used to check whether the settings are correct or not.

**HINT**

**Gateway server dialog box when using the multi-channel function**

Devices with channel No. 2 to 4 are displayed as "channel No." + "device".

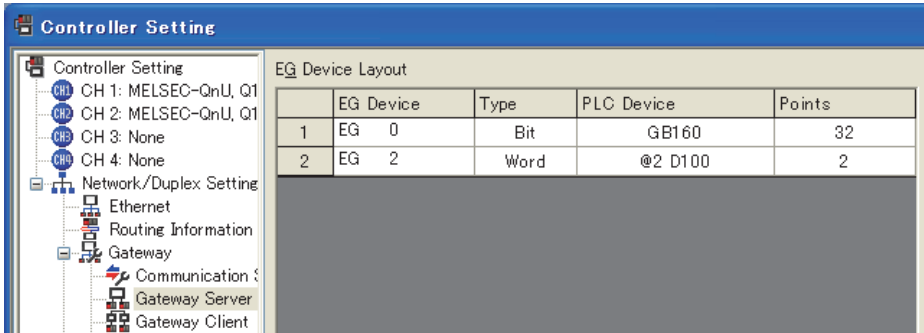

**(2) Precautions for device assignment**

Gateway devices are set on a two-point basis.

Hence, the number of assigned points changes depending on the controller device type to be set.

- (a) When assigning bit devices to gateway devices

Bit devices are assigned in 32-point units. (As 32 points are 2 words.)

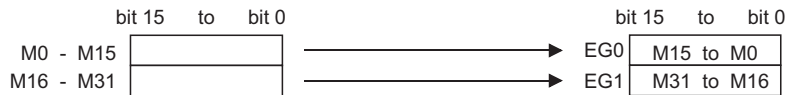

- (b) When assigning word devices to gateway devices

Word devices are assigned in 2-point units. (As 2 points are 2 words.)

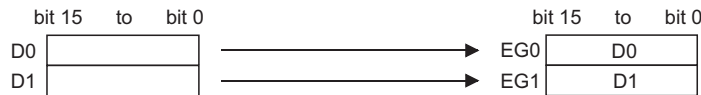

- (c) When assigning double-word devices to gateway devices

Double-word devices are assigned in 1-point units. (As 1 points are 2 words.)

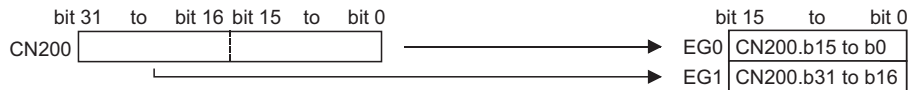

- (d) When assigning 8-bit devices to gateway devices

8-bit devices are assigned in 4-point units. (As 4 points are 2 words.)



## ■ Client setting

In the client setting, register the GOT (server) to be monitored by the GOT (client).

### (1) Client function setting method

1. Select [Common] → [Controller Setting] from the menu to display the Controller Setting dialog box.
2. Select [Gateway Client] and set the required items.

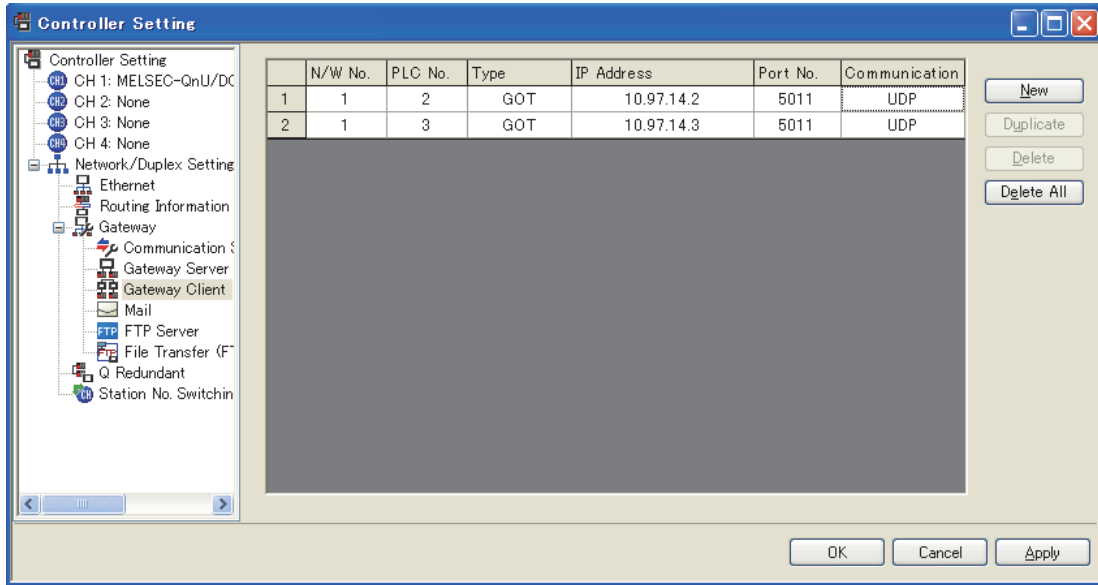

Item	Description
Server function GOT table	Register the GOTs (server) to be monitored by the GOT (client).
N/W No.	Register the network No. of the GOT.
PLC No.	Register the PLC No. (station number) of the GOT.
Type	Fixed to GOT.
IP Address	Register the IP address of the GOT.
Port No.	Fixed to 5011.
Communication	Fixed to UDP.
New	Used to add a new GOT (server).
Duplicate	Used to add a copy of the selected GOT (server).
Delete	Used to delete the selected GOT (server).
Delete All	Used to delete all GOTs (server).



# 4.5 Examples of Use

The following gives the examples of using the server and client functions.

## ■ Accessing the PLC from personal computer via a GOT

The personal computer (MX Component) displays the device values of EG0 to EG5 of GOT 1 (server).

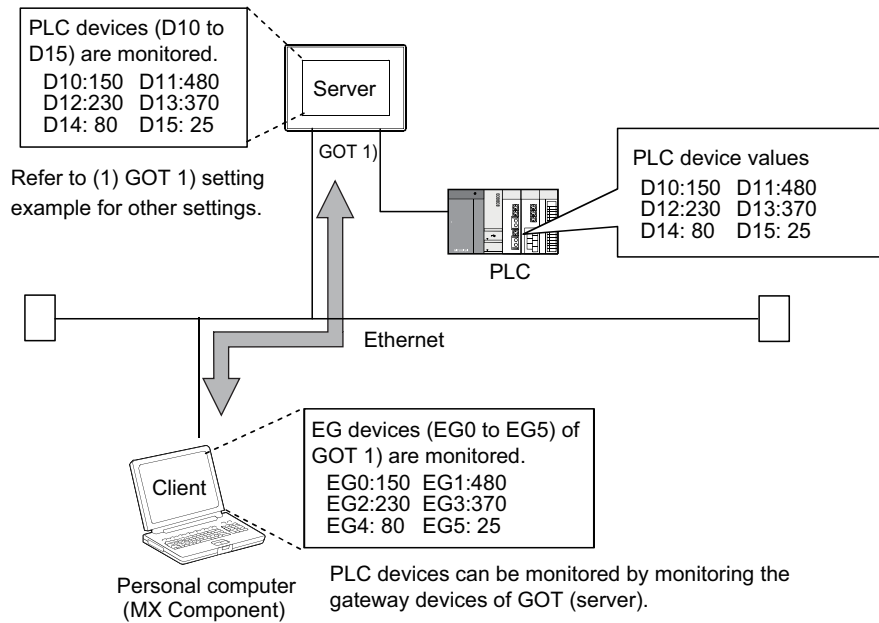

### (1) GOT 1) setting example

(a) Server setting

EG Device	PLC Device	Type	Points
EG0	D10	Word device	6

(b) Gateway Server dialog box

Item	Description
Device	D10 to D15
Network	Host

### (2) Personal computer settings

The personal computer (MX Component) accesses GOT 1 (server).

Refer to the following manuals for details of the MX Component.

- ☞ MX Component Version 3 Operating Manual
- MX Component Version 3 Programming Manual

## ■ Displaying on the GOT (client) the alarms that occurred at plural PLCs

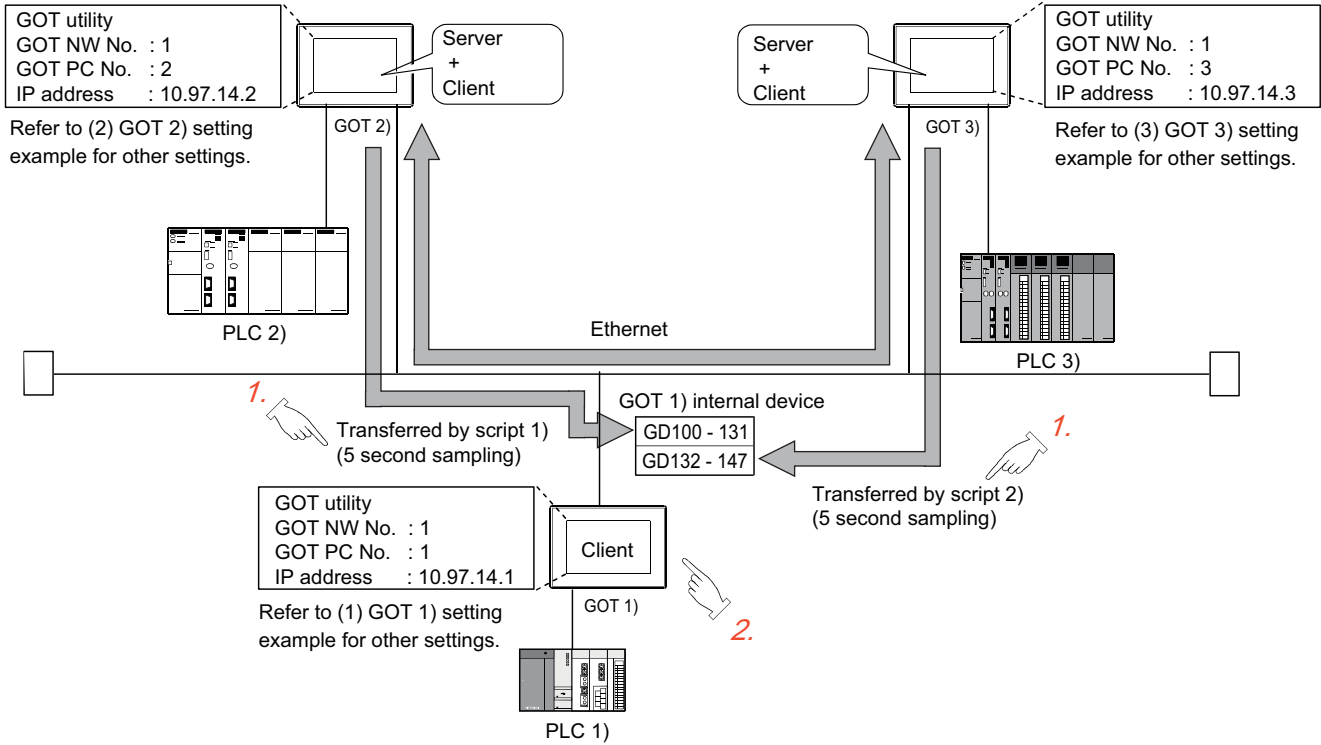

1. The device values of PLC 2) and PLC 3) are transferred to the internal devices (GD100 to GD147) of GOT 1).
2. GOT 1) monitors its own internal devices and displays the alarm occurrence information if an alarm occurs on PLC 2) or PLC 3).

**(1) GOT 1) setting example**

(a) Client setting

N/W No.	PLC No.	IP address
1	2	10.97.14.2
1	3	10.97.14.3

(b) Alarm history display function \*1 (for displaying alarms of GOT 2))

Item	Description
Number of device points (number of alarms)	512 points (consecutive points)
Device	GD100.b0

\*1 The comment to be displayed by the alarm history display function should be set beforehand.

(c) Alarm history display function \*1 (for displaying alarms of GOT 3))

Item	Description
Number of device points (number of alarms)	256 points (consecutive points)
Device	GD132.b0

\*1 The comment to be displayed by the alarm history display function should be set beforehand.

(d) Script function (for displaying alarms of GOT 2))

Item		Description
Script 1)	Type	Screen script
	Trigger Type	Sampling, 5 sec.
	Data Type	Unsigned BIN 16-bit
	Script example	<code>bmov([1-2:w:EG0],[w:GD100],32); //Transfers the data of 32 points, starting from EG0, of GOT 2) to D100 and on of GOT 1).</code>

(e) Script function (for displaying alarms of GOT 3))

Item		Description
Script 2)	Type	Screen script
	Trigger Type	Sampling, 5 sec.
	Data Type	Unsigned BIN 16-bit
	Script example	<code>bmov([1-3:w:EG0],[w:GD132],16); //Transfers the data of 16 points, starting from EG0, of GOT 3) to D132 and on of GOT 1).</code>

**(2) GOT 2) setting example**

(a) Server setting

EG Device	PLC Device	Type	Points
EG0	IB200	Bit device	512

**(3) GOT 3) setting example**

(a) Server setting

EG Device	PLC Device	Type	Points
EG0	..300	Bit device	256

**POINT**

**About the trigger type**

When setting the script function, do not set the trigger type as [Ordinary] or [Sampling, 2 sec.]. Such setting can adversely affect other monitoring operations.

## ■ Monitoring and controlling the production conditions of multiple PLCs with the GOT (server)

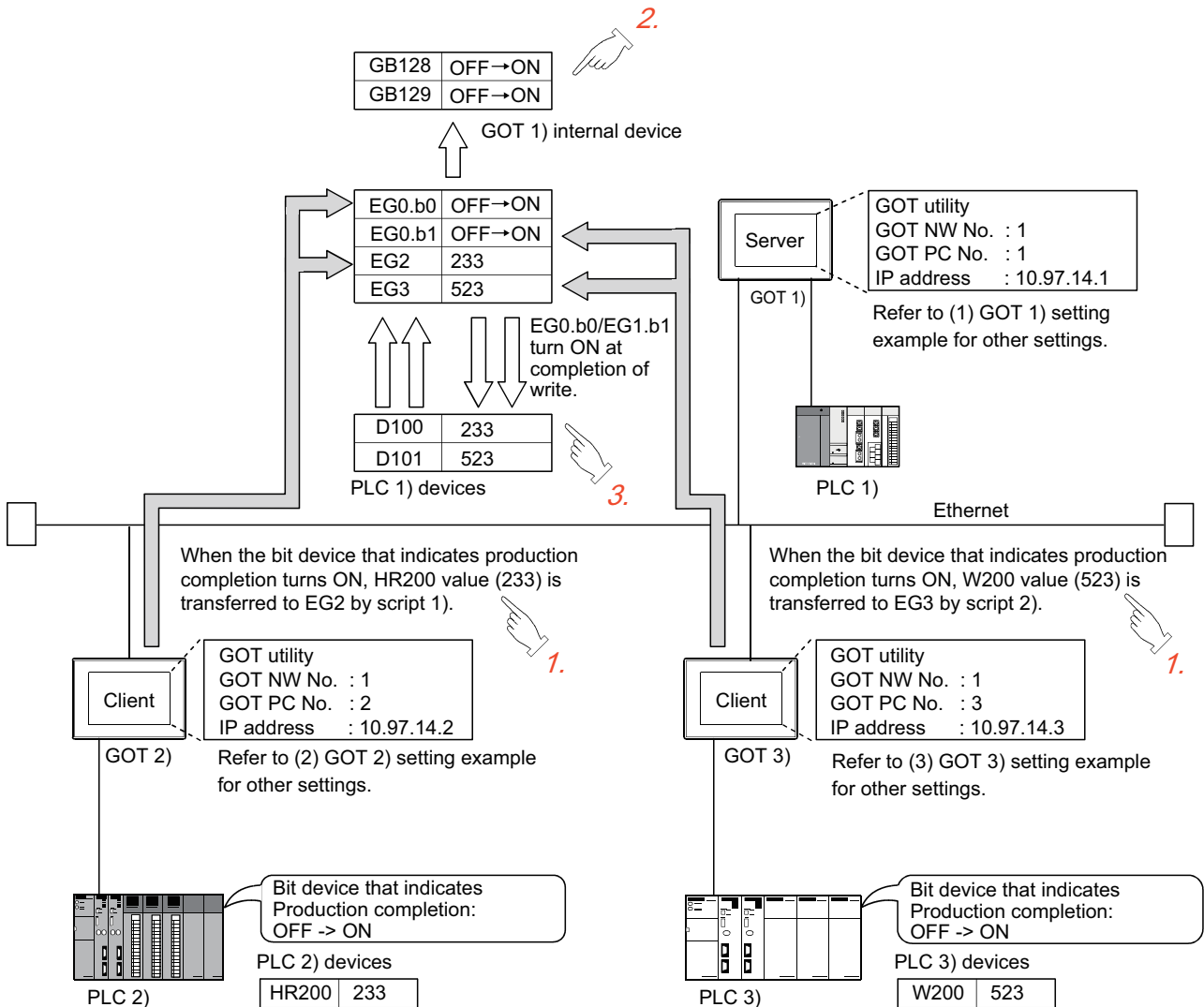

1. Device values of PLC 2) and PLC 3) are transferred to the EG devices (devices of PLC 1) of GOT 1) (server).
2. When the values are written to PLC 1), EG devices (internal devices, GB128 and GB129, of GOT 1) (server) turn ON. (Check the completion of write by the lamp display function or the like.)
3. GOT 1) (server) monitors the devices of PLC 1) to check the production conditions of PLC 2) and PLC 3).

**(1) GOT 1) setting example**

(a) Server setting

EG Device	PLC Device	Type	Points
EG0	GB128	Bit device	32
EG2	D100	Word device	2

(b) Numerical display function (setting for 2 devices)

Item	Description
Device	D100 and D101
Network	Host

(c) Lamp display function (setting for 2 devices)

Item	Description
Device	GB128 and GB129
Network	Host

**(2) GOT 2) setting example**

(a) Client setting

N/W No.	PLC No.	IP address
1	1	10.97.14.1

(b) Script function

Item	Description	
Script 1)	Type	Screen script
	Trigger Type	ON: Bit device that indicates the completion of production
	Data Type	Unsigned BIN 16-bit
	Script example	[1-1:w:EG2]=[w:HR200]; //Writes the production count to PLC 1). set([1-1:b:EG0.00]); //Turns ON the write completion signal.

**(3) GOT 3) setting example**

(a) Client setting

N/W No.	PLC No.	IP address
1	1	10.97.14.1

(b) Script function

Item	Description	
Script 2)	Type	Screen script
	Trigger Type	ON: Bit device that indicates the completion of production
	Data Type	Unsigned BIN 16-bit
	Script example	[1-1:w:EG3]=[w:W200];// Writes the production count to PLC 1). set([1-1:b:EG0.01]); //Turns ON the write completion signal.

## 4.6 Precautions

This section provides the precautions for using the server and client functions:

### ■ Precautions for assigning devices in the gateway setting

If a station number is changed while monitoring gateway devices to which PLC CPU devices are assigned, this change has no effect on the devices being monitored.  
Create the screen for each station.

Example) When station No. is changed for the GOT (server).

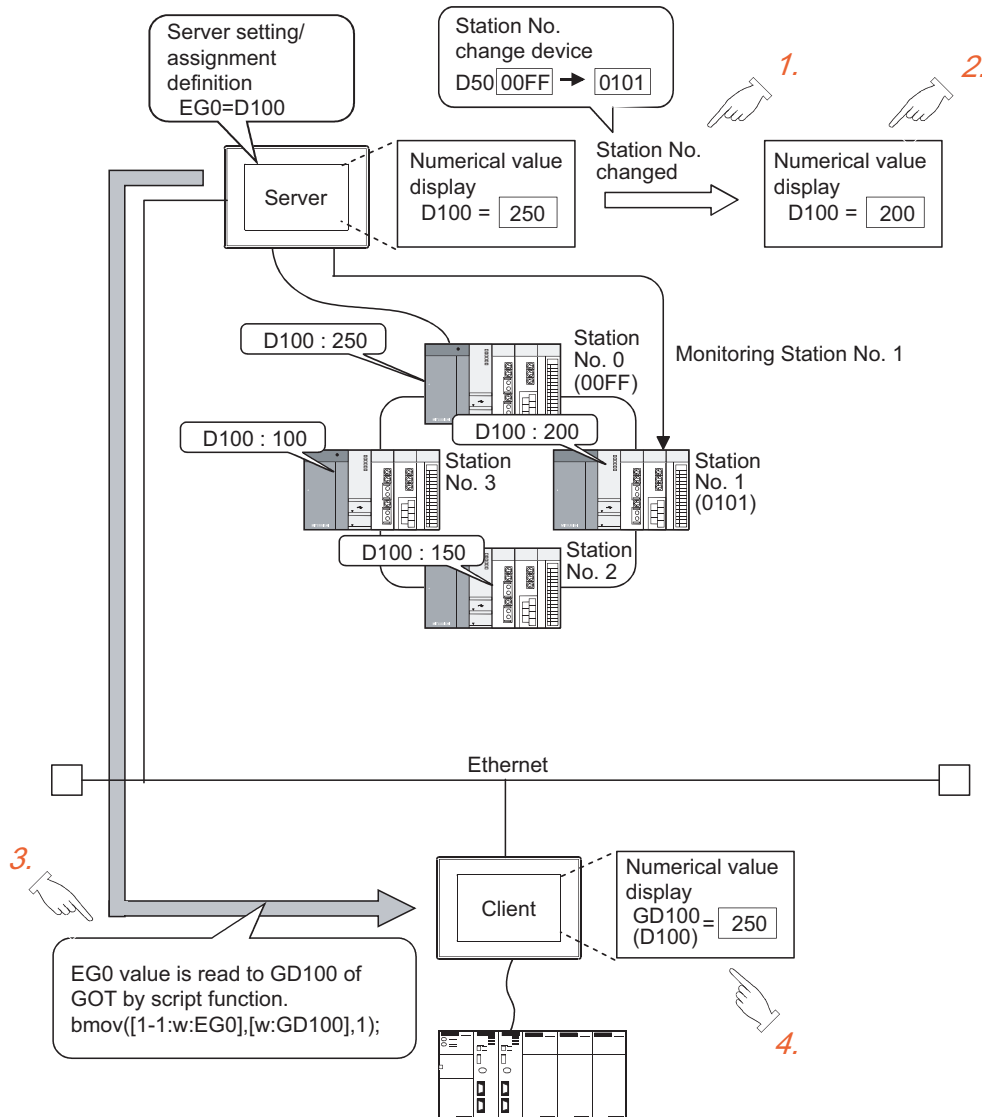

1. Change the station No.
2. The value displayed at the GOT (server) is updated according to the changing of the station No.
3. Since the changing of the station No. is not reflected to the assignment of gateway devices, the script function reads out the value at EG0 of PLC (station No. 0) to D100.
4. Changing of the station No. is disregarded and the value displayed at the GOT (client) is not updated.

## ■ Precautions for setting the script function

- (1) When setting the script function, do not set the trigger type as [Ordinary] or [Sampling, 2 sec.]. Such settings can adversely affect other monitoring operations.
- (2) The script function cannot be used to monitor the gateway devices of the GOT (GOT) itself where the script function is executed.  
To monitor the PLC devices assigned to the gateway devices, monitor the PLC devices directly.
- (3) In the script for accessing the gateway devices, specify the network No. and the PC station No. of the access destination GOT.  
Monitoring of the gateway devices is not possible even if 0-FF (host) is set for the destination of access.

## ■ Precautions for monitoring

- (1) If the gateway device of the GOT (server) is monitored in the state the server or client function cannot be used\*<sup>1</sup>, a script execution error (error code 16) occurs at the GOT (client) and the execution of a script stops. Refer to the following manual for errors that may occur during the execution of a script.

 GT Designer 3 Version1 Screen Design Manual (Functions)

\*<sup>1</sup> While the power is off, when the OS of the GOT is not compatible with the server/client function, when an optional function board is not fitted, etc.

- (2) When the gateway device to which the PLC device is not assigned is monitored, it is monitored as 0 (OFF if a bit device is specified).  
When write is executed, the written value is invalid.
- (3) During the execution of the script that uses gateway devices, screen save time may be influenced.
  - (a) At the cancellation of the screen save function  
Canceling of the screen saved state of the GOT (by a screen touch or human sensor) may take a longer time than usual.  
(When the script processing time is 2 seconds, for example, the screen save function is canceled in a maximum of 2 seconds after the screen is touched.)
  - (b) At the start of the screen save function  
When the automatic screen save function is set, screen save execution intervals may be longer than the specified interval.

## 4.7 For Efficient Use

This section explains the points to be taken into consideration to use the server and client functions efficiently.

### ■ Script function setting

When gateway devices are used directly to execute a program, the number of times to access other GOTs increases and causing the processing to slow down.

By performing batch read from the internal devices of the GOT and performing batch write after the execution of processing as explained in (1) below, the number of access times decreases and thus improves the processing speed.

#### (1) When performing batch read from the GOT internal devices (GD) and batch write to them after the execution of processing

Access to the other station GOT occurs twice ( 1), 3)).

When one access requires 50 ms, a total of about 100 ms is taken for two times of accessing and internal processing at access destination.

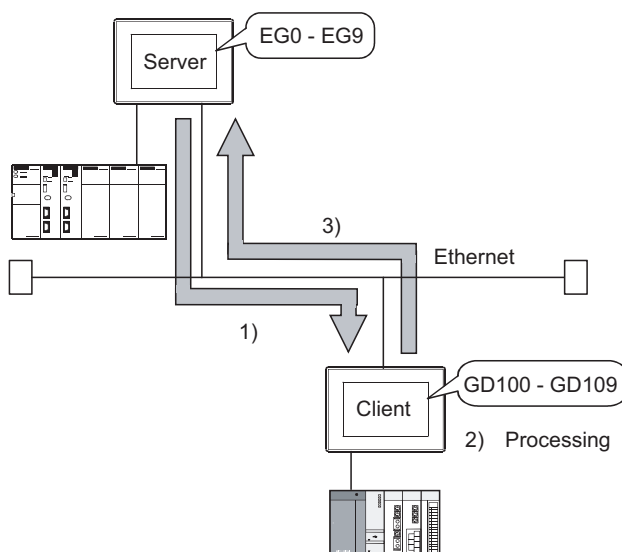

#### Script example

1)	bmov([1-2:w:EG0],[w:GD100],10); [w:D200]=[w:GD100]; [w:D201]=[w:GD101]; [w:D202]=[w:GD102]; [w:D203]=[w:GD103]; [w:D204]=[w:GD104];
2)	[w:GD105]=128; [w:GD106]=[w:D106]; [w:D205]=[w:GD107]; [w:D206]=[w:GD108]; [w:GD109]=5433;
3)	bmov([w:GD100],[1-2:w:EG0],10);

#### (2) When using gateway devices directly

Access to the other station GOT occurs 10 times ( 1) to 10))

When one access requires 50 ms, a total of about 500 ms is taken for ten times of accessing and internal processing at access destination.

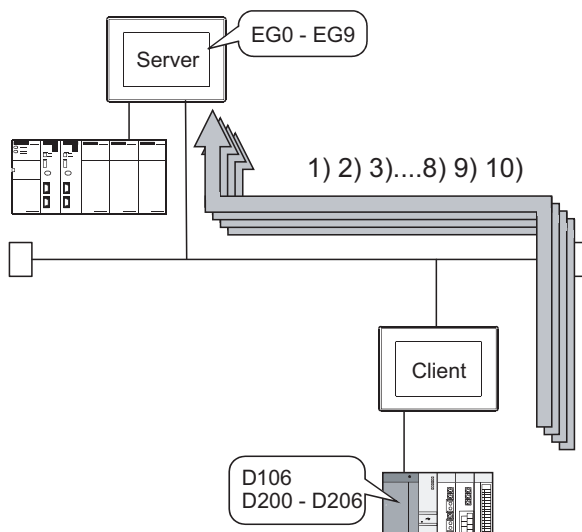

#### Script example

1)	[w:D200]=[1-2:w:EG0];
2)	[w:D201]=[1-2:w:EG1];
3)	[w:D202]=[1-2:w:EG2];
4)	[w:D203]=[1-2:w:EG3];
5)	[w:D204]=[1-2:w:EG4];
6)	[1-2:w:EG5]=128;
7)	[1-2:w:EG6]=[w:D106];
8)	[w:D205]=[1-2:w:EG7];
9)	[w:D206]=[1-2:w:EG8];
10)	[1-2:w:EG9]=5433;



## POINT

### About the values to be written

In the case of (1), explained on the previous page, the gateway devices are batch-accessed when the script execution conditions are established. Therefore, gateway device values set when the conditions are established are processed as the written values.

In the case of (2), explained on the previous page, the gateway devices are accessed one by one to execute processing. Therefore, these values may differ from the values set at the gateway devices when the conditions are established.

## Gateway device setting

When assigning the PLC devices to the gateway devices, set the same type of devices of the same PLC together where possible.

By setting the same type of devices of the same PLC together as in (1) below, the number of access times is decreased to improve the processing speed.

### (1) Devices of host, other stations and other PLCs are set together

When the GOT (client) accesses the host devices of the GOT (server), access is possible with program 1) that reads 50 points starting from EG0.

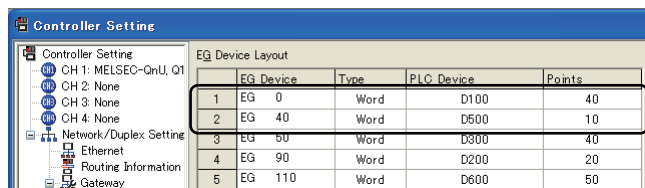

	EG Device	Type	PLC Device	Points
1	EG 0	Word	D100	40
2	EG 40	Word	D500	10
3	EG 80	Word	D300	40
4	EG 90	Word	D200	20
5	EG 110	Word	D600	50

#### Script example

1) `bmov([W:GD100],[1-2:w:EG0],50);`

### (2) Devices of host, other stations and other PLCs are not set together

When the GOT (client) accesses the host devices of the GOT (server), access requires two programs - program 1) that reads 40 points starting from EG0 and program 2) that reads 10 points starting from EG130.

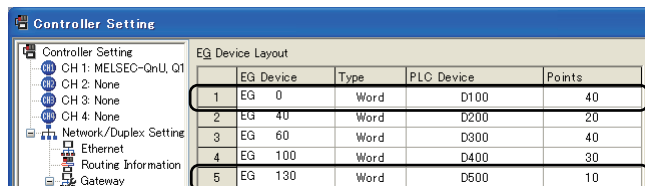

	EG Device	Type	PLC Device	Points
1	EG 0	Word	D100	40
2	EG 40	Word	D200	20
3	EG 60	Word	D300	40
4	EG 100	Word	D400	30
5	EG 130	Word	D500	10

#### Script example

1) `bmov([W:GD100],[1-2:w:EG0],40);`  
2) `bmov([w:GD140],[1-2:w:EG130],10);`



**To further increase efficiency**

By reserving together in advance the PLC devices to be used for the server and client functions in the system design stage as shown in (a) below, the number of times the GOT (server) accesses the PLC is reduced to improve the processing speed.

(a) When PLC devices are assigned together

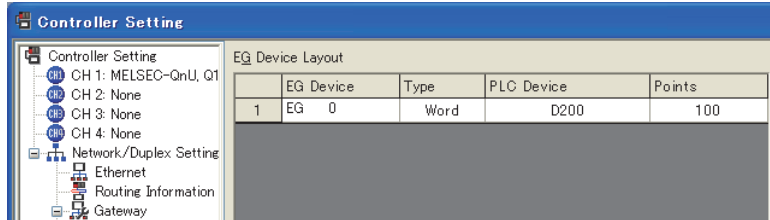

The GOT access the PLC once to read/write the whole 100 points.

(b) When PLC devices are not assigned together

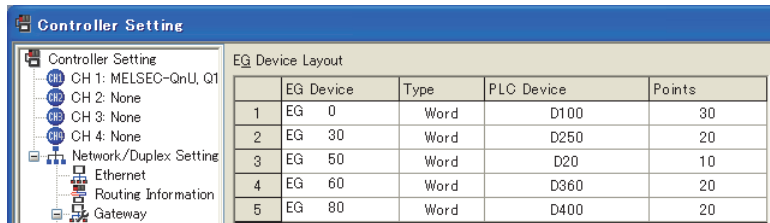

The GOT has to access the PLC at least 5 times to read/write all these 100 points.

**■ Performance of the server / client function (reference values)**

The following table indicates the performance of the server and client functions (reference values) when ■Script function setting and ■Gateway device setting, explained on the previous pages, are used.

The reference values of the performance assume the following conditions.

- There are one GOT (server) and one GOT (client) on the system.
- GOT (server): Numerical input (64 points) setting
- GOT (client): Numerical input (64 points) setting
- Number of assigned device points: 10 word devices

Combinations for Improving the Efficiency		Response Speed in Direct CPU connection
Improving the Script Function Efficiency	Improving the Gateway Device Setting Efficiency	
○ (in the case of ■Script function setting (1) in this section)	○ (in the case of ■Gateway device setting (1) in this section)	Approx. 260 ms
○ (in the case of ■Script function setting (1) in this section)	× (in the case of ■Gateway device setting (2) in this section)	Approx. 1300 ms
× (in the case of ■Script function setting (2) in this section)	○ (in the case of ■Gateway device setting (1) in this section)	
× (in the case of ■Script function setting (2) in this section)	× (in the case of ■Gateway device setting (2) in this section)	

When there are multiple GOTs (client), the response speed is "Response speed in the table × Number of GOTs (client)".

# 5. MAIL SEND FUNCTION

---



This chapter describes the mail send function.

## POINT

**(1) About the mail software**

The GOT (send source) does not require mail software.

**(2) About the system when using the mail send function**

The SMTP (mail) server must be installed in the intranet to use the mail send function.

**(3) Mail send function**

The function sends mail at the occurrence of, or restoration from, an alarm managed by the alarm history display function.

Refer to the following manual for details of the alarm history display function.

 GT Designer 3 Version1 Screen Design Manual (Functions)

1	OVERVIEW
2	SYSTEM CONFIGURATION
3	GENERAL PROCEDURE TO BE FOLLOWED FOR USING
4	SERVER AND CLIENT FUNCTIONS
5	MAIL SEND FUNCTION
6	FTP SERVER FUNCTION
7	FILE TRANSFER FUNCTION (FTP CLIENT)
8	TROUBLE SHOOTING

## 5.1 Specifications

### 5.1.1 Specifications

The specifications of the mail send function are given below:

Item	Specifications	Setting Method
SMTP server	IP address setting (1 server only)	GT Designer3
	Port	25
	Server authentication	Disabled
Send destination address	To	1 to 32 (Max. 64 characters / address: Alphanumeric characters only)
	Cc	1 to 32 (Max. 64 characters / address: Alphanumeric characters only)
	Bcc	
Subject	Max. 128 characters (Alphanumeric characters only)	GT Designer3
Text data size	Can send two basic comments indicated below. Basic comment displayed as an alarm history message : Max. 512 characters (Alphanumeric characters) Basic comment displayed in the comment window, in detail display of the alarm history. : Max. 512 characters (Alphanumeric characters)	-
Attachments	Disabled	-
Encoding	No	-
Compression	No	-
Memory space used by GOT (bytes)	$20 + 4 \times (\text{Number of destinations} + 2) + 2 \times (\text{Total number of characters of destination, subject and sender})$	GT Designer3

The table below shows the mail software program for which correct operation is confirmed by Mitsubishi Electric.

Name	Maker
OutlookExpress6, Outlook2003, Outlook2007, Outlook2010	Microsoft Corporation

## 5.1.2 Mail send enabled range

Since the IP address is used to specify the SMTP server in the mail send function of a GOT, a dial-up router cannot be used to send mail. (The SMTP server of the Internet service provider cannot be used.)  
Install the SMTP (mail) server in the intranet.

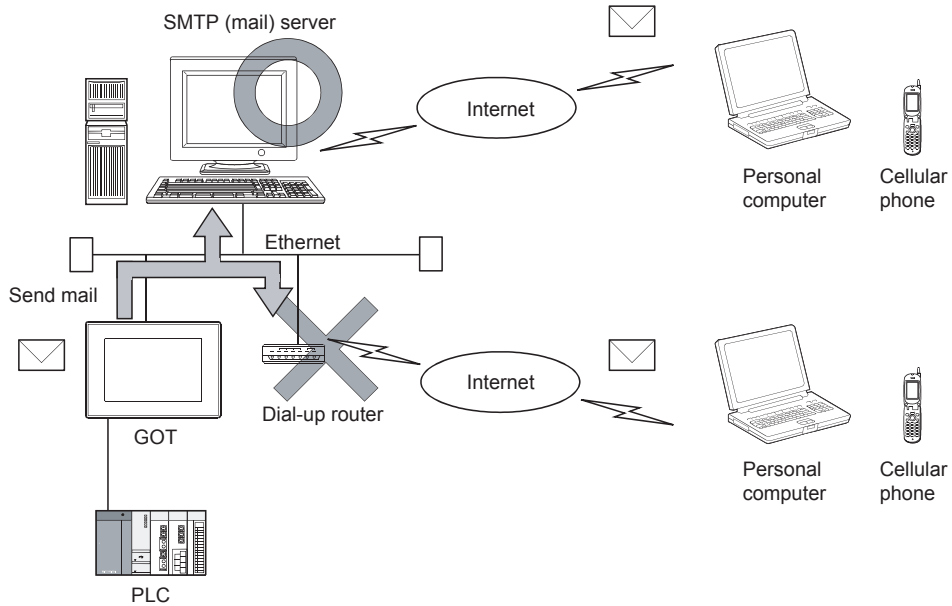

1

OVERVIEW

2

SYSTEM  
CONFIGURATION

3

GENERAL PROCEDURE  
TO BE FOLLOWED FOR  
USING

4

SERVER AND  
CLIENT FUNCTIONS

5

MAIL SEND  
FUNCTION

6

FTP SERVER  
FUNCTION

7

FILE TRANSFER  
FUNCTION  
(FTP CLIENT)

8

TROUBLE  
SHOOTING

## 5.2 System Configuration

This section explains the system configuration of the mail send function.

### ■ Connection with SMTP mail server

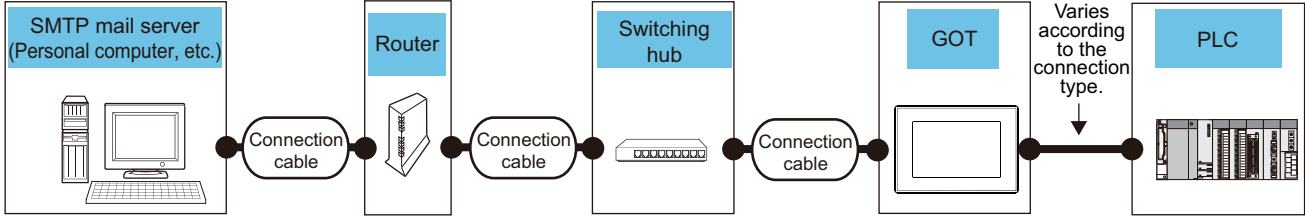

SMTP mail server	Connection cable	Router* <sup>2</sup>	Switching hub	GOT										
				OS	Option device	Model* <sup>4</sup>								
Personal computer, etc.	Shielded twisted pair cable (STP) Category 5	A router that meets the IEEE802.3 100BaseTX standard.* <sup>1</sup>	A switching hub that meets the IEEE802.3 100BaseTX standard.* <sup>1</sup>	Option OS (Gateway(Mail))	- (Built into GOT)	<table border="1"> <tr><td>GT16</td><td>GT15</td></tr> <tr><td>GT14</td><td>GT12</td></tr> <tr><td>GT11</td><td>GT10</td></tr> <tr><td colspan="2">SoftGOT1000</td></tr> </table>	GT16	GT15	GT14	GT12	GT11	GT10	SoftGOT1000	
					GT16	GT15								
					GT14	GT12								
GT11	GT10													
SoftGOT1000														
GT15-J71E71-100	<table border="1"> <tr><td>GT16</td><td>GT15</td></tr> <tr><td>GT14</td><td>GT12</td></tr> <tr><td>GT11</td><td>GT10</td></tr> <tr><td colspan="2">SoftGOT1000</td></tr> </table>	GT16	GT15	GT14	GT12	GT11	GT10	SoftGOT1000						
GT16	GT15													
GT14	GT12													
GT11	GT10													
SoftGOT1000														
Option function board* <sup>3</sup>	<table border="1"> <tr><td>GT16</td><td>GT15</td></tr> <tr><td>GT14</td><td>GT12</td></tr> <tr><td>GT11</td><td>GT10</td></tr> <tr><td colspan="2">SoftGOT1000</td></tr> </table>	GT16	GT15	GT14	GT12	GT11	GT10	SoftGOT1000						
GT16	GT15													
GT14	GT12													
GT11	GT10													
SoftGOT1000														

\*<sup>1</sup> When using routers or switching hubs with security settings available, enable the communication with the port No. to be used.

\*<sup>2</sup> A router is required only when connecting to a SMTP mail server on another network.

\*<sup>3</sup> Use the following option function board.

Option function board
GT15-FNB, GT15-QFNB, GT15-QFNB16M, GT15-QFNB32M, GT15-QFNB48M, GT15-MESB48M

\*<sup>4</sup> For GT14, only GT1455-QTBDE and GT1450-QLBDE can be used.

### POINT

#### Communication interface setting

For the communication interface setting, refer to the following.

☞ 2.2 Types of Controller to GOT Connection

## 5.3 Setting Method

Only one mail setting can be made for one GOT.

1. Select [Common] → [Controller Setting] from the menu to display the Controller Setting dialog box.
2. Select [Mail] and set the required items.

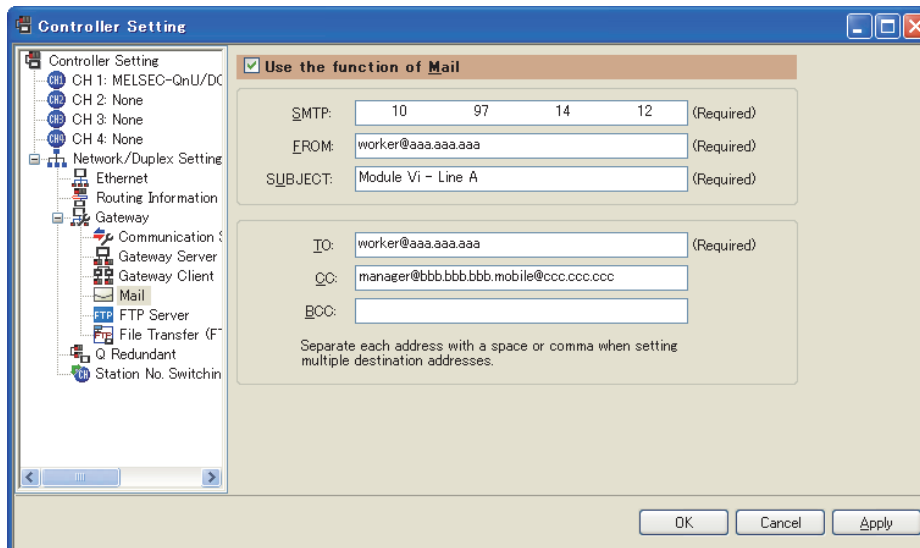

Item	Description
Use the function of Mail	Check this item to use the mail send function.
SMTP	Set the IP address of the SMTP server.
FROM	Enter the address of the mail send source. (Alphanumeric characters only) Since a GOT does not have the mail receive function, set the address where reply should be sent back in the "FROM" field. When there is no specific reply destination, set the address as set in "TO".
SUBJECT* <sup>1</sup>	Enter the title of the mail. (Alphanumeric characters only)
TO* <sup>2</sup>	Enter the address of the mail send destination.
CC	Enter the address of the mail send destination (carbon copy). (Alphanumeric characters only. Specify if required.)
BCC	Enter the address of the mail send destination (blind carbon copy). (Alphanumeric characters only. Specify if required.)

\*1 Better to enter different SUBJECTs to identify the mail sending GOT from multiple GOTs.

\*2 When setting multiple send destination addresses, separate them with a space or a comma.

## 5.4 Mail Send Examples

When mail is sent from a GOT to the target device, the message indicating that the mail has been sent from a GOT is displayed in the header of the received mail.

Example of the indication of send source in the header of the received mail

```

From:*****
To:*****
Cc:*****
Subject:Module VI - Line A
X-Mailer:GOT
  
```

### POINT

#### About sending mail

- (1) The format and contents of the display of the mail having been sent vary depending on the specifications of the mail software installed at the destination.
- (2) When mail is sent to a cellular phone, the display may vary depending on the specifications (screen size) of the cellular phone.
- (3) If more than 16 events of occurrence of or restoration from an alarm took place at the same time, only the information of the first 16 events is sent.

#### ■ When sending mail using the alarm history display function

If an alarm occurs in a GOT, the time and information of alarm occurrence are sent to the destination.

If the GOT is recovered from the alarm, the recovery time and information is sent to the destination by a mail.

Refer to the following manual for the alarm history display function setting method.

 GT Designer 3 Version1 Screen Design Manual (Functions)

#### (1) Example of display at the destination

```

(a) → [Alarm history occurred information]
      [Occur Time]
      2005/02/14 09:48:15
      [Occur Information]
      Line A supply conveyor stopped.
(b) → [detailed Information]
      X2 ON
      Alarm history: A-line supply converter stopped.
      Check the power source.
  
```

(At the occurrence of alarm)

```

(a) → [Alarm history repaired information]
      [repair Time]
      2005/02/14 10:38:23
      [repair Information]
      Alarm "Line A supply conveyor stopped." recovered.
      Alarmhistory:detail comment nothing
  
```

(At the restration from alarm)

- (a) The comment set for the alarm history display function is displayed.
- (b) The contents of detail information ([Detail]) set for the alarm history display function is displayed. If "Not display", "Base screen" or "Window screen" is set for the alarm history display function, specific detail information is not displayed.  
(In this case, "Alarm history: detail comment nothing" is displayed for [detailed Information].)  
To display the information for [detailed Information], set the information to be displayed at the Comment window.



# 5.5 Examples of Use

Examples of how the mail send function is used is given below.

## ■ Sending the contents of the alarm that occurred in the GOT to the production site and the office by mail

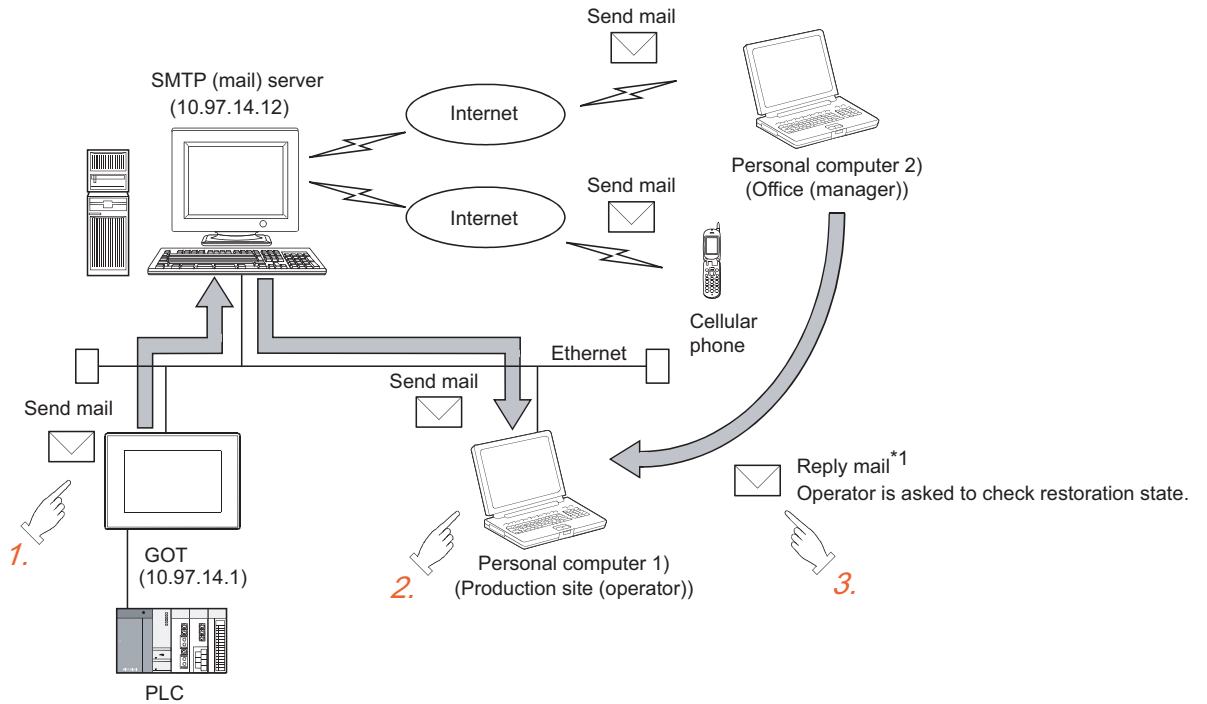

\*1 Since a GOT cannot receive a mail, set the mail address of the personal computer at the production site for "FROM". Thus the manager in the office can reply a mail to the production site to get further more information.

1. If an alarm occurs in a GOT, a mail is sent to the personal computer 1 (production site (operator)), cellular phone and personal computer 2 (office (manager)).
2. At the production site, an operator repairs the system to recover its function.
3. At the office, the manager can send a mail to the production site, requesting the report on the status of restoration.

### (1) GOT setting example

#### (a) Utility of GOT

Item	Description
GOT IP Address	10.97.14.1
Delay Time	0 (× 10 ms)
Timeout Time	3 sec.
Startup Time	3 sec.

(b) Mail setting

Item	Description
SMTP Server	10.97.14.12
FROM	Mail address of personal computer 1) (production site (operator))
TO	Mail address of personal computer 1) (production site (operator))
CC	Mail address of personal computer 2) (office (manager)) Mail address of cellular phone
SUBJECT	Module VI - Line A

(c) Alarm history display function<sup>\*1</sup> (Alarm History screen)

Item	Description
Device	Controller device to be monitored
Send mail	At the occurrence of alarm / At the recovery from alarm

\*1 The comment to be displayed by the alarm history display function should be set beforehand.

## 5.6 Precautions

---

The precautions for using the mail send function are described below:

- (1) The languages that can be sent by mail are Japanese and English.  
Other languages, if used, are sent in the symbol of "?".
- (2) When mail is sent from multiple GOTs to the same mail address, set the subject specific to the individual GOTs so that the mail sending GOT can be identified.  
If the same subject is set at multiple GOTs, it becomes difficult to find the GOT that has sent a specific mail.
- (3) Depending on the clock setting at a GOT (time setting/time notification), problems may occur including the problem that the setting of the clock data at the GOT or controller is not valid.  
Refer to the following manual for clock setting of a GOT.

 GT Designer 3 Version1 Screen Design Manual (Fundamentals)

- (4) The date/time of the SMTP server is taken as the mail send date/time.

# 6. FTP SERVER FUNCTION



This chapter describes the FTP server function.

## 6.1 Specifications

### 6.1.1 Specifications

The specifications of the FTP server function are indicated below.

Item	Specifications	Setting method
FTP server function setting	Whether the function will be used or not can be set (default: Not used)	GT Designer3
User name	1 to 12 alphanumeric characters (case sensitive, use of "anonymous" is prohibited) (default: GOT1000)	GT Designer3
Password	1 to 8 alphanumeric characters (case sensitive) (default: GOT1000)	GT Designer3
Port No.	20, 21	Fixed
Number of clients that can be connected simultaneously	1 unit	Fixed
Watching timer of command input	Before login <sup>*1</sup>	1 min.
	After login <sup>*2</sup>	1 to 60 min. (default: 15 min.)
File size that can be read	Unlimited (Max. read size depends on memory card capacity.)	-
File name <sup>*3</sup>	Only alphanumeric characters	-
Access mode	Normal: Reference mode (write to memory card disabled) Write is enabled after issue of dedicated command	-
Usable FTP client <sup>*4</sup>	<ul style="list-style-type: none"> <li>FTP client conformed to RFC 959</li> <li>Access by FTP command from the command prompt of Windows<sup>®</sup> is available.</li> <li>The passive mode is supported.</li> </ul>	-
Memory space used by GOT (bytes)	Total number of 12 + (2× the number of characters used for login name and password)	-

\*1 The line is disconnected if a correct password and login name are not entered within 1 minute after a line connection with the GOT.

\*2 The GOT disconnects the line if a command is not input from the FTP client within the time set to the watching timer of command input.

\*3 Refer to the following for the file names that can be set.

6.4.2 File specifying method

\*4 The following table shows the FTP client whose correct operation is confirmed by Mitsubishi Electric.

FTP client	Target device/OS
Microsoft <sup>®</sup> Internet Explorer 5 or later	Microsoft <sup>®</sup> Windows <sup>®</sup> 98 Operating System, Microsoft <sup>®</sup> Windows <sup>®</sup> Millennium Edition Operating System, Microsoft <sup>®</sup> Windows NT <sup>®</sup> Workstation 4.0 Operating System, Microsoft <sup>®</sup> Windows <sup>®</sup> 2000 Professional Operating System, Microsoft <sup>®</sup> Windows <sup>®</sup> XP Professional Operating System, Microsoft <sup>®</sup> Windows <sup>®</sup> XP Home Edition Operating System
Netscape Communicator 7.1 or later	
FFFTP Ver. 1.82 or later (freeware)	
NextFTP Ver. 2 (shareware)	
FTP function of Mitsubishi data collection analyzer, MELQIC	IU2-3M10, IU2-3M10L (firmware version 1.82 or later), IU1-1M20-D

GOT-dedicated commands cannot be used when using Microsoft<sup>®</sup> Internet Explorer or Netscape Communicator.

## 6.1.2 Accessible file range

---

The FTP server function can access the GOT within the network to which the FTP client is connected.  
(Multiple clients cannot access the GOT simultaneously.)  
When using a relay device such as a router, consult the network manager.

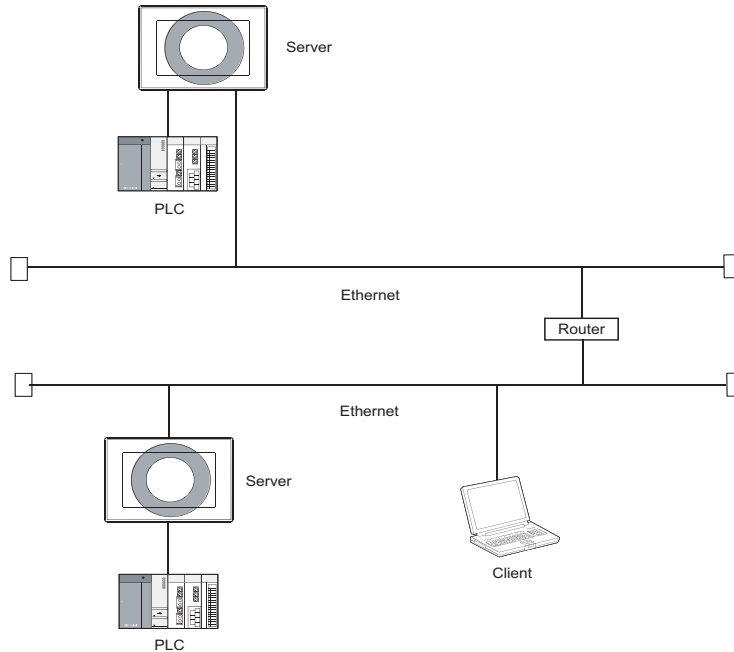

### HINT

#### Simple determination of whether a file can be accessed or not

Whether a file can be accessed or not can be determined simply by issuing the ping command to the GOT.

Example of issuing the ping command (Window<sup>®</sup> scommand prompt)

IP address of GOT: 10.97.14.10

- When a file can be accessed

```
C:\>ping 10.97.14.10
pinging 10.97.14.10 with 32 byte of data:
reply from 10.97.14.10 : Fbytes=32 time<10ms ttl=128
reply from 10.97.14.10 : Fbytes=32 time<10ms ttl=128
reply from 10.97.14.10 : bytes=32 time<10ms ttl=128
C:\>
```

- When a file cannot be accessed

```
C:\>ping 10.97.14.10
pinging 10.97.14.10 with 32 byte of data:
request timed out.
request timed out.
request timed out.
C:\>
```

## 6.2 System Configuration

This section explains the system configuration of the FTP server function.

### ■ Connection with FTP client

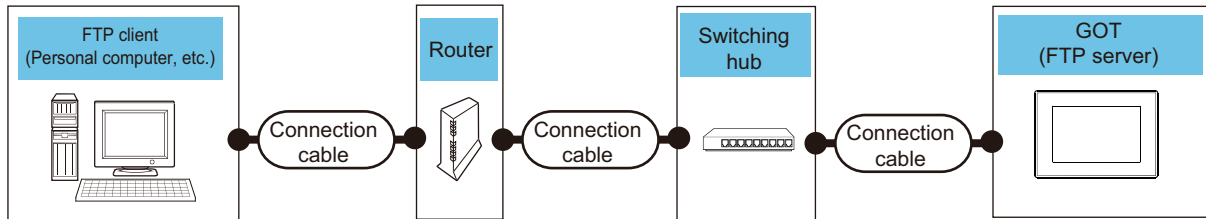

FTP client	Connection cable	Router*2	Switching hub	GOT (FTP server)										
				OS	Option device	Model*5								
Personal computer, etc.*6	Shielded twisted pair cable (STP) Category 5	A router that meets the IEEE802.3 100BaseTX standard.*1	A switching hub that meets the IEEE802.3 100BaseTX standard.*1	Option OS (Gateway(FTP Server))	Memory card*3 /USB memory	<table border="1"> <tr><td>gr16</td><td>gr15</td></tr> <tr><td>gr14</td><td>gr12</td></tr> <tr><td>gr11</td><td>gr10</td></tr> <tr><td colspan="2">SoftGoT1000</td></tr> </table>	gr16	gr15	gr14	gr12	gr11	gr10	SoftGoT1000	
					gr16	gr15								
					gr14	gr12								
					gr11	gr10								
SoftGoT1000														
Memory card*3	<table border="1"> <tr><td>gr16</td><td>gr15</td></tr> <tr><td>gr14</td><td>gr12</td></tr> <tr><td>gr11</td><td>gr10</td></tr> <tr><td colspan="2">SoftGoT1000</td></tr> </table>	gr16	gr15	gr14	gr12	gr11	gr10	SoftGoT1000						
gr16	gr15													
gr14	gr12													
gr11	gr10													
SoftGoT1000														
GT15-J71E71-100	<table border="1"> <tr><td>gr16</td><td>gr15</td></tr> <tr><td>gr14</td><td>gr12</td></tr> <tr><td>gr11</td><td>gr10</td></tr> <tr><td colspan="2">SoftGoT1000</td></tr> </table>	gr16	gr15	gr14	gr12	gr11	gr10	SoftGoT1000						
gr16	gr15													
gr14	gr12													
gr11	gr10													
SoftGoT1000														
CF card*3	<table border="1"> <tr><td>gr16</td><td>gr15</td></tr> <tr><td>gr14</td><td>gr12</td></tr> <tr><td>gr11</td><td>gr10</td></tr> <tr><td colspan="2">SoftGoT1000</td></tr> </table>	gr16	gr15	gr14	gr12	gr11	gr10	SoftGoT1000						
gr16	gr15													
gr14	gr12													
gr11	gr10													
SoftGoT1000														
					Option function board*4									

\*1 When using routers or switching hubs with security settings available, enable the communication with the port No. to be used.

\*2 A router is required only when connecting to a GOT (client) on another network.

\*3 For the usable memory card, refer to the following.

☞ User's Manual for the GOT used

\*4 Use the following option function board.

Option function board
GT15-FNB, GT15-QFNB, GT15-QFNB16M, GT15-QFNB32M, GT15-QFNB48M, GT15-MESB48M

\*5 For GT14, only GT1455-QTBDE and GT1450-QLBDE can be used.

\*6 For the FTP client whose correct operation is confirmed by Mitsubishi Electric, refer to the following.

☞ 6.1.1 Specifications

### POINT

#### Communication interface setting

For the communication interface setting, refer to the following.

☞ 2.2 Types of Controller to GOT Connection

## 6.3 Setting Method

1. Select [Common] → [Controller Setting] from the menu to display the Controller Setting dialog box.
2. Select [FTP Server] and set the required items.

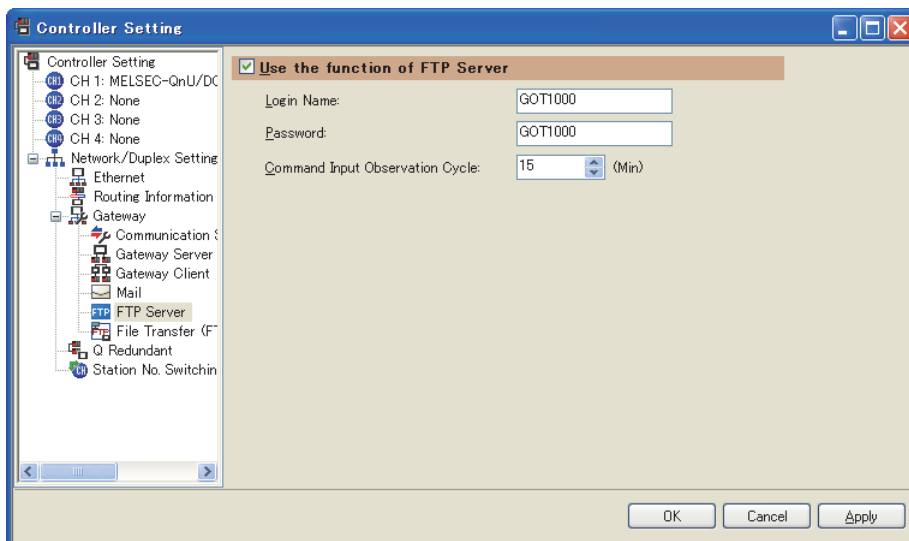

Item	Description
Use the function of FTP Server	Check this item when using the FTP server function.
Login Name	Set the login name used when the FTP client connects to the GOT. Only one login name and the login name up to max. 12 characters can be set. Only alphanumeric characters (a to z, A to Z, 0 to 9) can be used. The default is GOT1000.
Password	Set the password used when the FTP client connects to the GOT. Only one password and the password up to max. 8 characters can be set. Only alphanumeric characters (a to z, A to Z, 0 to 9) can be used. The default is GOT1000.
Command Input Observation Cycle	Set the time when the line with the GOT will be disconnected if no command is entered from the FTP client. The time can set in the range from 1 to 60 min. in 1 min. increments. Normally, use the default setting (15 min).

## 6.4 Operation on FTP Client Side

### 6.4.1 Input command at FTP client

#### ■ General commands

The following table shows the correspondence between general commands usable in the command prompt and FTP client, and the server function of the GOT.

The following commands may not be used depending on the specifications of the FTP client to use.

○ : Usable × : Unusable

Command name	Function	Reference mode	Write mode
append	Additionally writes a file to the GOT.	×	○
ascii	Changes the file transfer mode to the ascii mode.	○	○
binary	Changes the file transfer mode to the binary mode.	○	○
bye	Exits the FTP client tool.	○	○
cd	Changes the current directory of the GOT.	○	○
close	Disconnects the line with the GOT.	○	○
delete	Deletes a file in the GOT.	×	○
dir	Reads the file information in the GOT.	○	○
get	Reads a file from the GOT.	○	○
ls	Displays file names in the GOT.	○	○
mdelete	Deletes multiple files specified using a wild card.	×	○
mdir	Reads the file information in the GOT to the specified file.	○	○
mget	Reads multiple files specified using a wild card.	○	○
mkdir	Creates a directory in the GOT.	×	○
mls	Reads the file names in the GOT to the specified file.	○	○
mput	Writes the specified multiple files using a wild card to the GOT.	×	○
open	Connects the line with the GOT.	○	○
put	Writes a file to the GOT.	×	○
pwd	Displays the current directory of the GOT.	○	○
rename	Changes file names in the GOT.	×	○
rmdir	Deletes a directory in the GOT.	×	○
quit	Disconnects the line with the GOT and exits the FTP client tool.	○	○
quote	Used when the GOT-dedicated command is used for the command prompt. (Example: quote gtwr)	○	○
user	Enters the user name and password used to log in to the GOT.	○	○

#### ■ GOT-dedicated commands

When the line with the GOT is connected, the FTP client is in the "reference mode" in which file read-only is enabled. Before writing or deleting the file or creating a directory, change it to the "write mode".

To select the reference mode or write mode, issue a mode change command.

○ : Usable × : Unusable △ : Setting invalid (command does not result in error)

Command name*1	Function	Reference mode	Write mode
gtwr	Changes the FTP server function mode of the GOT to the write mode.	○	△
gtrd	Changes the FTP server function mode of the GOT to the reference mode.	△	○
help	Displays the general-purpose actual commands of the FTP protocol supported by the FTP server function of the GOT.	○	○
gtds	Enables access to the C drive in the GOT.	×	○

\*1 When entering the GOT-dedicated command for the command prompt, use "quote".  
Example: When entering "gtwr" for the command prompt.  
quote gtwr

## 6.4.2 File specifying method

There are two file specifying methods: one is to specify one file directly and the other is to specify multiple files that meet the condition.

### ■ Specifying the file name to read

Specify the file name of the file to be specified, period and extension.

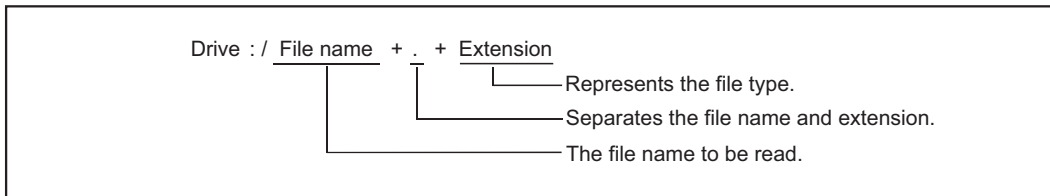

#### (1) Drive

Specify the following drives.

Model	Drive to be specified
GT16	A: Standard CF Card, B: Extended Memory Card, C: Built-in flash memory, E: USB memory
GT15	A: Standard CF Card, B: Extended Memory Card, C: Built-in flash memory
GT14	A: Standard SD Card, C: Built-in flash memory, D: Built-in SRAM, E: USB memory
GT12	A: Standard CF Card, C: Built-in flash memory, D: Built-in SRAM

#### (2) Number of characters set for folder or file name

GOT recognizes the file location according to the path explained below.

Specify the folder name and file name, with the total characters of the path not exceeding 78 characters.

Only folder and file names can be set by the user.

(Information other than the folder and file names is automatically added.)

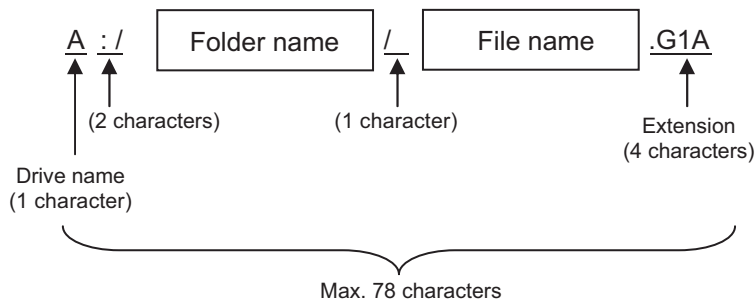

#### When setting a hierarchy to the folder

When setting a folder name, enter a forward slash ("/") between folder names.

(/ is counted as one character.)

(Setting example)

[Folder name]: Project1/abc

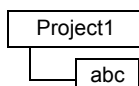



**(3) Character strings that cannot be set**

The following character strings cannot be used as a folder or file name (regardless of case).

- COM1 to COM9    • LPT1 to LPT9    • AUX            • CON
- NUL                    • PRN                    • CLOCK\$

The following folder and file names cannot be used.

- Folder names starting with G1
- Folder or file names starting with a period (".") or forward slash ("/").
- Folder or file names ending with a period (".") or forward slash ("/").
- Folder or file names with only one or two periods (". " or "..")

**(4) Extensions**

The FTP server function mainly uses files with the following extensions.

Extension	Application on GOT
csv	Advanced alarm file (advanced alarm function), alarm history file (alarm history display function), operation log file (operation log function), logging file (logging function), recipe file (recipe function), advanced recipe file (advanced recipe function)
txt	Advanced alarm file (advanced alarm function), operation log file (operation log function), logging file (logging function), recipe file (recipe function), advanced recipe file (advanced recipe function)
bmp	Image data (hardcopy function)
jpg	
3GP	Video files (multimedia function)

**POINT****Reading binary format files**

Turning on GS400.b8 (Bit position: 8) of GOT special register enables direct read of a binary format file (\*.G1 □) from an FTP client.

Note that reading of the following binary format files is not allowed.

- \*.G1
- \*.G1D

Binary format files read to the GT Designer3 can be used as backups.

Some files can be converted with the GT Designer3.

For file conversion on the GT Designer3, refer to the following manual.

 GT Designer3 Version1 Screen Design Manual (Functions)

**■ Specifying the files that meet the condition (wild card)**

When specifying multiple files, "\*" or "?" as a wild card can be used.

(Example)

When specifying only JPEG files.....\*.jpg

When specifying CSV files that begin with Main.....Main\*.csv

When specifying files whose extensions begin with b.....\*.b??

**POINT****About accessing files**

Deleting certain files may cause any malfunctions to the GOT.

To prevent the GOT from malfunctioning, do not delete any files inside of the GOT from the FTP client.

### 6.4.3 Checking the line connection status

The connection status of the line between the GOT and FTP client is stored in the GOT special register GS200.b2 (bit position: 2).

By referring to this bit on the GOT, check whether or not the line is connected.

Device name	ON	OFF
GS200.b2	Connected	Disconnected

Refer to the following manual for details of the GOT special registers.

 GT Designer3 Version1 Screen Design Manual (Fundamentals)



#### Example of using GS200.b2

- (1) Using the above device with the lamp display function, a line status confirmation indicator is available.

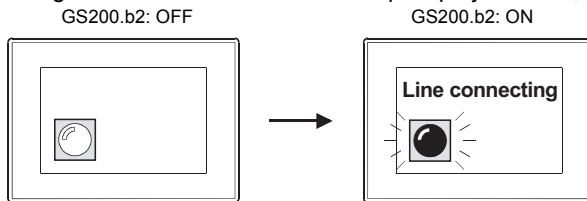

- (2) By setting the above device to the operation condition as a trigger using the touch switch function or numerical input function, operation (input) can be restricted while the line is connected.

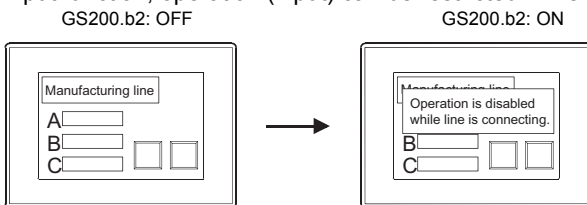

Using the touch key function or numerical input function, make setting to enable input only when the device (GS200.b2) is OFF.

## 6.4.4 Line disconnection

There are two line disconnection methods: automatic and manual disconnection.

### ■ Automatic disconnection

The GOT disconnects the line automatically if no command is entered from the FTP client within the time set to the watching timer of command input in the FTP server setting.

The watching timer of command input is always set.

Refer to the following for the setting of the watching timer of command input.

 6.3 Setting Method

### ■ Manual disconnection (Forcibly disconnecting the line)

Using the GOT special register GS400.b2 (bit position: 2), the line is forcibly disconnected.

To disconnect the line, turn "ON" GS400.b2 (bit position: 2).

Refer to the following manual for details of the GOT special registers.

 GT Designer3 Version1 Screen Design Manual (Fundamentals)

### POINT

#### Precautions when using GS400.b2

After confirming that the line has been disconnected, turn "OFF" GS400.b2.

### HINT

#### About disconnecting the line

Since the GOT cannot detect the fault status of the FTP client, it does not disconnect the line immediately if the FTP client cannot exit properly (e.g., when the personal computer is powered off while the line is connected).

However, because the watching timer of command input is set, the line is disconnected automatically in a predetermined time.

1

OVERVIEW

2

SYSTEM CONFIGURATION

3

GENERAL PROCEDURE TO BE FOLLOWED FOR USING

4

SERVER AND CLIENT FUNCTIONS

5

MAIL SEND FUNCTION

6

FTP SERVER FUNCTION

7

FILE TRANSFER FUNCTION (FTP CLIENT)

8

TROUBLE SHOOTING

## 6.5 Example of Use

The following is an example of the use of the FTP server function.

In this example, the Windows® MS-DOS command prompt is used for accesses between the GOT and FTP client. When performing operations using a commercially available FTP client tool, refer to the manual of the FTP client tool used.

### ■ General procedure

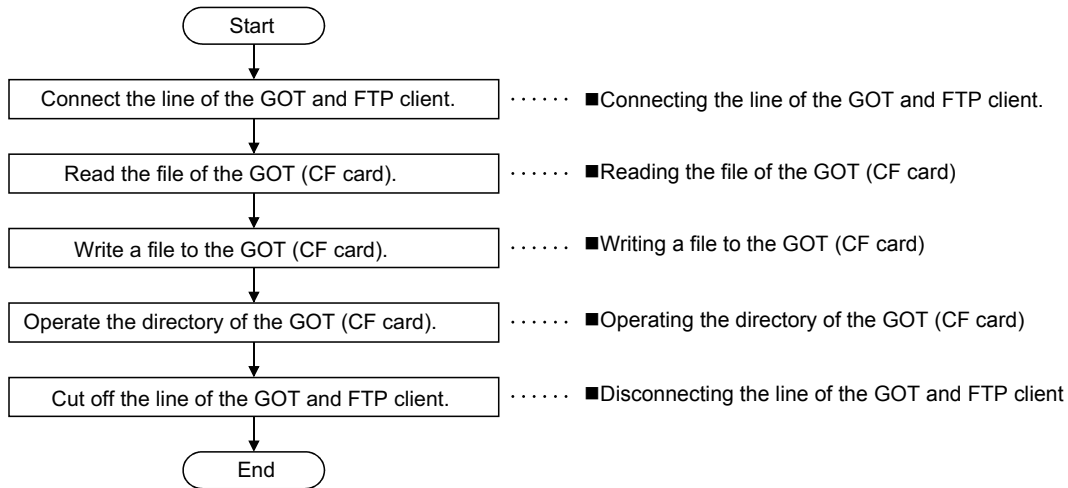

### POINT

When writing a file to the GOT (Memory card) or operating the directory, turn on the CF card access switch of the GOT to make the memory card write-enabled.

### ■ System configuration example

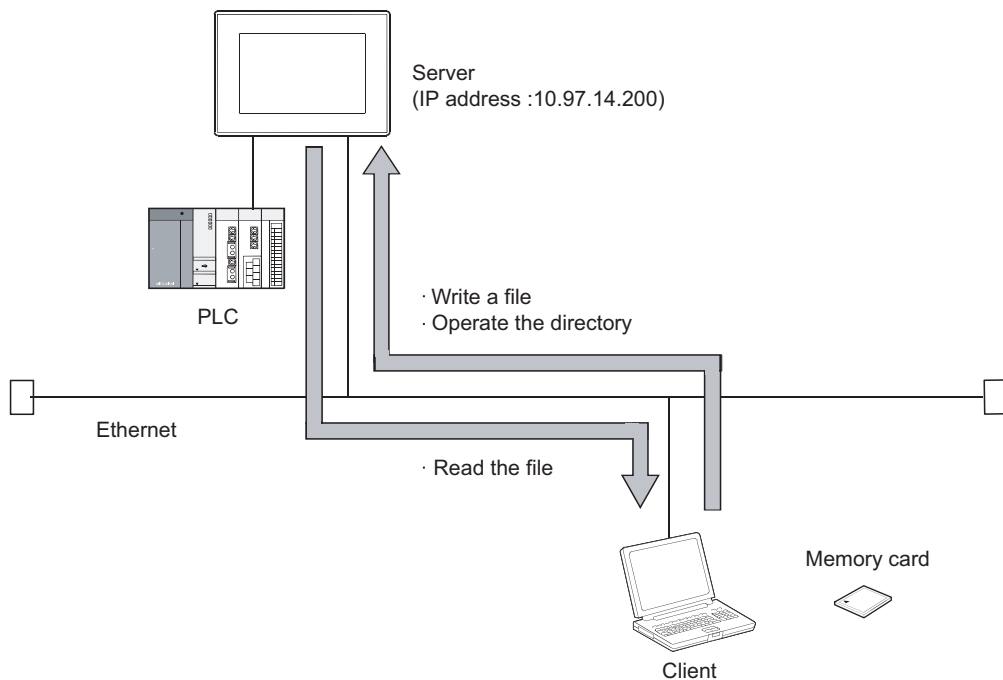

## ■ Connecting the line of the GOT and FTP client.

Use the following procedure to connect the GOT and FTP client.

1. Starting the FTP client.....ftp ↵
2. Connecting to the GOT.....open + GOT IP address ↵
3. Inputting the login name.....Login name ↵
4. Inputting the password.....Password ↵

Login image (when the line is connected properly)

```
C:\>ftp
ftp>open 10.97.14.200
connected to 10.97.14.200
220 GOT1000 FTP server ready.
user:GOT1000
331 Password required.
Password:****
230 User logged in.
ftp>
```

Login image (when another personal computer is already connected to the GOT)

```
C:\>ftp
ftp>open 10.97.14.200
connected to 10.97.14.200
421 Session limit reached, closing control connection
user:GOT1000
connection closed by remote host
ftp>
```

Login image (when the password is incorrect)

```
C:\>ftp
ftp>open 10.97.14.200
connected to 10.97.14.200
220 GOT1000 FTP server ready.
user:GOT1000
331 Password required.
Password:****
530 Not logged in.
ftp>
```

## ■ Reading the file of the GOT (CF card)

Use the following procedure to read the file.

1. Notifying of no file conversion.....binary ↵
2. Reading file.....get + file name ↵

Read image

```
ftp>binary
TYPE is now BINARY.
ftp>get SNAP0001.BMP
200 PORT command successful
150 Opening connection.
226 Closing data connection.
ftp: 63 bytes sent in 0.00 seconds 63000.00
K bytes/sec.
ftp>
```

## ■ Writing a file to the GOT (CF card)

Use the following procedure to write a file.

1. Notifying of no file conversion.....binary ↵
2. Selecting the write mode.....quote gtwr ↵
3. Displaying the file name to check for the same file name  
.....ls ↵ or dir ↵
4. Deleting the same file when exists.....delete + file name ↵
5. Writing file.....put + file name ↵

Write image

```
ftp>binary
TYPE is now BINARY.
ftp>quote gtwr
200 command successful.
ftp>ls
200 PORT command successful.
150 Opening connection.
SNAP0001.BMP
SNAP0002.BMP
226 Closing data connection.
ftp>delete SNAP.0001.BMP
File deleted Successfully.
ftp>put SNAP0001.BMP
200 PORT command successful
150 Opening connection.
226 Closing data connection.
ftp: 63 bytes sent in 0.00 seconds 63000.00
K bytes/sec.
ftp>
```

## ■ Operating the directory of the GOT (CF card)

Use the following procedure to create and change the directory.

1. Displaying current directory.....pwd ↵
2. Selecting the write mode.....quote gtwr ↵
3. Creating directory.....mkdir + directory name ↵
4. Changing current directory.....cd + directory name ↵

Directory operation image

```
ftp>pwd
257 "A:/snapshot" is current directory.
ftp>quote gtwr
200 command successful.
ftp>mkdir bmpdata
275 MKD command successful.
ftp>cd bmpdata
250 CWD command successful.
ftp>pwd
257 "A:/snapshot/bmpdata" is current directoryftp>cd ..
250 CWD command successful.
ftp>pwd
257 "A:/snapshot" is current directory.
ftp>
```

## ■ Disconnecting the line of the GOT and FTP client

Use the following procedure to disconnect the GOT and FTP client.

1. Quit command.....quit ↵

Logout (line disconnection) image

```
ftp>quit
221 User logged out. Good-Bye.
C:\>
```

## ■ Error display

An error that occurs in the FTP server function is displayed on the FTP client. Refer to the following for the displayed error messages.

### 8.5.1 Error codes and error messages

If an attempt is made to read a file (snap0010.bmp) that does not exist

```
ftp>get snap0010.bmp
200 PORT command successful.
550 snap0010.bmp: FNo such file or directory.
ftp>
```

## 6.6 Precautions

---

The following are precautions when using the FTP server function.

### ■ Precautions for system design using the FTP server function

- (1) When writing a recipe file from the FTP client to the GOT, set the format of the recipe file as set for the recipe function of the GOT.  
When writing a recipe file from a remote location, confirm the operation with the field site personnel before writing.
- (2) Before using the FTP client tool, refer to the manual of the FTP client tool, confirm its functions and operation methods, and test it before starting operation.  
Depending on the FTP client tool used, the GOT (FTP server) may not support some operations.  
Also, depending on the FTP client tool used, the FTP server function may not be usable because the GOT cannot support the extended command (quote) and issue GOT-dedicated commands.
- (3) If a number of files are read at once under one command (e.g., mget or mput is executed by specifying a wild card), processing may be delayed by network congestion.  
If processing is slow, issue commands separately to process more fast.

### ■ Precautions for file transfer

- (1) The GOT disconnects the line if no command is input from the FTP client for longer than the time set to the watching timer of command input.
- (2) The line remains connected if the GOT goes offline (e.g., the monitor screen data is downloaded) while the GOT and FTP client are connected.
- (3) When change (rewrite) the contents of the recipe file, make the recipe inactive.  
If the recipe file in the memory card is deleted during recipe processing, the function will not operate properly.  
If the recipe file is deleted at a time other than during recipe processing, an error (system alarm: recipe file error) will occur in the next recipe operation.

( 6.4.3 Checking the line connection status)

- (4) Check that writing of the file is performed correctly when overwriting a file in the GOT using FTP.  
If an error occurs during writing of the file, the file being written in the GOT is deleted.  
Write the file again using FTP.
- (5) If the FTP client has become faulty (personal computer), wait until the time set to the watching timer of command input elapses or turn the forced logout signal "GS400.b2" on to disconnect the line, and log in again.  
The line connection status can be checked using "GS200.b2" (bit position: 2).
- (6) Do not power the GOT off while accessing the file in the memory card of the GOT from the FTP client.  
Doing so may damage the data in the memory card.
- (7) If reset or power off the GOT while the GOT and FTP client are connected, the operation of the FTP client depends on the specifications of the FTP client tool used.  
Use an FTP client tool that supports the detection of FTP server faults or that can be exited properly.
- (8) Write processing (put) cannot be performed if CF card access switch of the GOT main unit is off.
- (9) Write processing (put) cannot be performed if the write protect switch of the memory card is on.  
Depending on the FTP client tool used, the time stamp may differ from that of the file in the memory card of the GOT. If the time stamp differs, check the setting of the FTP client tool.



## ■ Precautions for FTP login

- (1) If forgot the password for FTP login, connecting to the GOT is not applicable. Confirm the set password using GT Designer2.
- (2) Multiple FTP clients cannot login to the GOT simultaneously.
- (3) If enter an incorrect user name or password for FTP login in the FTP software, exit the FTP client and login again.
- (4) The user authentication dialog box may not be displayed when using Microsoft® Internet Explorer. Enter the GOT address in the following format.  
ftp://<user name>:<password>@<GOT address name or host name>/

Example: Default setting

ftp://GOT1000:GOT1000@192.168.0.18/



# 7. FILE TRANSFER FUNCTION (FTP CLIENT)



This chapter describes the file transfer function (FTP client).

## 7.1 Specifications

### 7.1.1 Specifications

The specifications of the file transfer function (FTP client) are given below.

Item	Specifications
Usable FTP server	FTP server conformed to RFC 959*1
Number of connectable FTP servers	Max. 16
Number of file transfer settings	Max. 100
Transfer mode	In the stream mode, the communication is performed with binary data. PORT mode and Passive mode are supported.

\*1 The following table shows the FTP server whose correct operation is confirmed by Mitsubishi Electric.

FTP server	Target device/OS
FTP server function of the GOT	GT16, GT15, GT14
FTP server of web server module (QJ71WS96)	Web server module (QJ71WS96)
Microsoft® Internet Information Services (IIS)	Microsoft® Windows Server® 2008 R2 Microsoft® Windows Server® 2008 Microsoft® Windows Server® 2003 Microsoft® Windows® 7 Microsoft® Windows Vista®
ProFTPD	Vine Linux
FTP server of Cognex vision sensor (In-Sight EZ series)	Cognex vision sensor (In-Sight EZ series)
FTP function of Mitsubishi data collection analyzer, MELQIC	IU2-3M10, IU2-3M10L (firmware version 1.83 or later), IU1-1M20-D
FTP server function of C Controller module	Q24DHCCPU-V, Q12DCCPU-V, Q06CCPU-V, Q06CCPU-V-B

## 7.1.2 Accessible file range

---

The GOT (FTP client) can access the FTP server within the network to which the GOT is connected. It also can access the GOT (FTP server).

To connect to another network FTP server, the router is required.

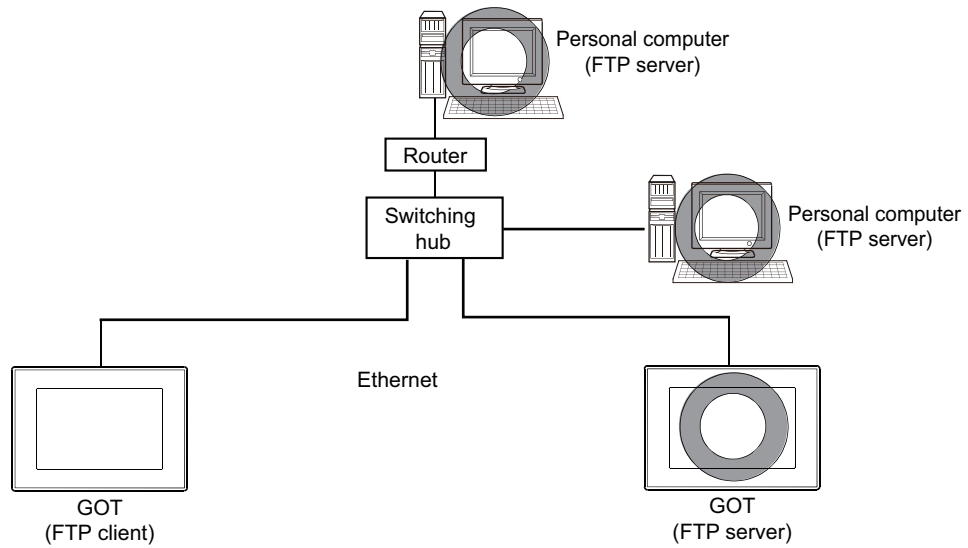

## 7.2 System Configuration

This section explains the system configuration of the file transfer function (FTP client).

### ■ Connection with FTP server

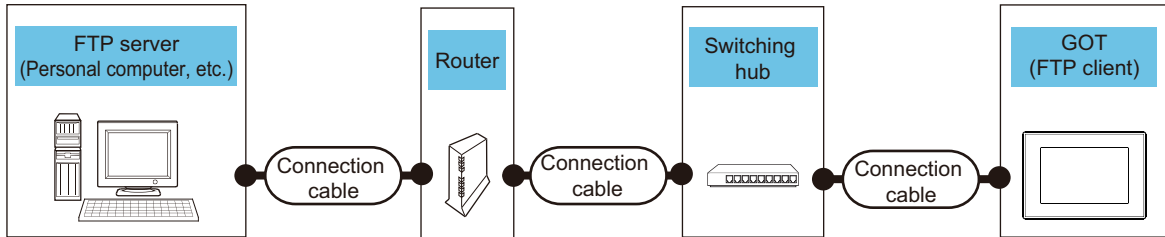

FTP server	Connection cable	Router <sup>*1</sup>	Switching hub	GOT		
				OS <sup>*2</sup>	Option device	Model <sup>*4</sup>
Personal computer, etc. <sup>*5</sup>	Shielded twisted pair cable (STP) Category 5	A router that meets the IEEE802.3 100BaseTX standard.	A switching hub that meets the IEEE802.3 100BaseTX standard.	Extended function OS (FTP client function)	Memory card <sup>*3</sup> /USB memory	gr16 gr15 gr14 gr12 gr11 gr10 SoftGOT1000
					GT15-J71E71-100	gr16 gr15 gr14 gr12 gr11 gr10 SoftGOT1000
					CF card <sup>*3</sup>	gr16 gr15 gr14 gr12 gr11 gr10 SoftGOT1000

\*1 A router is required only when connecting to a GOT (client) on another network.

\*2 Write data with the OS of GT Designer3 Version\*\*\* or later.

\*3 For the usable memory card and optional function board, refer to the following.

☞ User's Manual for the GOT used

\*4 For GT14, only GT1455-QTBDE and GT1450-QLBDE can be used.

\*5 For the FTP server whose correct operation is confirmed by Mitsubishi Electric, refer to the following.

☞ 7.1.1 Specifications

### POINT

#### Communication interface setting

For the communication interface setting, refer to the following.

☞ 2.2 Types of Controller to GOT Connection

## 7.3 Setting Method





The file transfer function (FTP client) requires the GOT (FTP client) setting and FTP server setting.

### 7.3.1 GOT (FTP client) setting

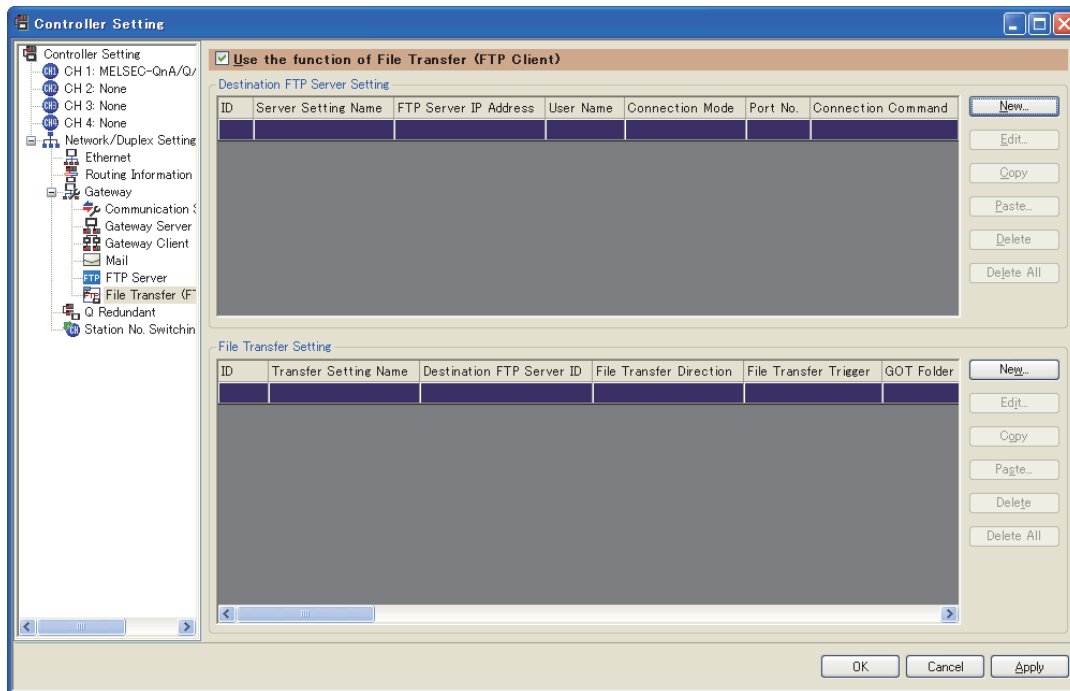



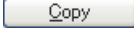
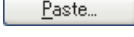
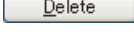
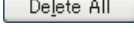

Set GOT (FTP client) with GT Designer3.

1. Select [Common] → [Controller Setting] from the menu to display the Controller Setting dialog box.
2. Select [File Transfer(FTP Client)] and set the required items.

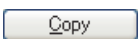
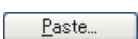

Item	Description
Use the function of File Transfer (FTP Client)	Check this item to use the file transfer function (FTP client).
Destination FTP Server Setting	Displays connection settings with the FTP server in a list. Up to 16 FTP servers can be registered.
	 Used to add a destination FTP server setting. Click it to display the [Destination FTP Server Setting] dialog box. Add a new destination FTP server setting.  ■Destination FTP Server Setting dialog box
	 Used to change the contents of the selected destination FTP server setting. Click it to display the [Destination FTP Server Setting] dialog box. Edit a new destination FTP server setting.  ■Destination FTP Server Setting dialog box
	 Click it to copy the contents of the selected destination FTP server setting.
	 Used to paste the contents of the copied destination FTP server setting. Click it to display the dialog box for specifying the server setting ID of copy destination. Specify the FTP server setting ID.
	 Click it to delete the contents of the selected destination FTP server setting.
	 Click it to delete the contents of the all destination FTP server settings.

(Continued to next page)

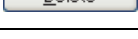
Item	Description
File Transfer Setting	Displays file transfer settings in a list. Up to 100 settings can be registered.
	 Add a file transfer setting. Click it to display the [File Transfer Setting] dialog box. Add a new file transfer setting.  ■File transfer setting dialog box
	 Used to change the contents of the selected file transfer setting. Click it to display the [File Transfer Setting] dialog box. Edit a file transfer setting.  ■File transfer setting dialog box
	 Click it to copy the contents of the selected file transfer setting.
	 Used to paste the contents of the copied file transfer setting. Click it to display the dialog box for specifying the file transfer ID of the copy destination. Specify the file transfer ID.
	 Click it to delete the contents of the selected file transfer setting.
	 Click it to delete the contents of all file transfer settings.

### ■ Destination FTP Server Setting dialog box

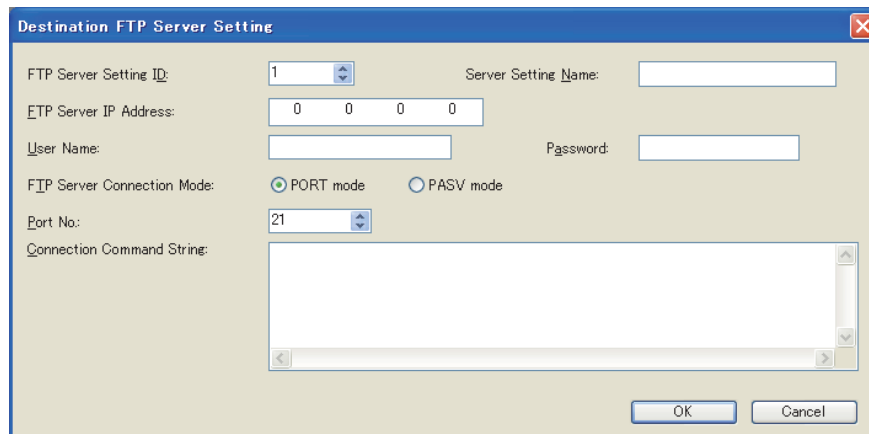

Item	Description
FTP Server Setting ID	Set an ID to specify the destination FTP server setting. (1~32767) Select a number different from that of other destination FTP server settings.
Server Setting Name	Set the name of a destination FTP server setting. Up to 32 characters can be set in both one-byte and two-byte.
FTP Server IP Address	Set an IP address of a destination FTP server.
User Name	Set a user name to log in to the FTP server. A user name can be set in 1 to 32 one-byte alphanumeric characters and symbols.
Password	Set a password to log in to the FTP server. A password can be set in 0 to 16 one-byte alphanumeric characters and symbols.
FTP Server Connection Mode	Set the connection mode of the FTP server. <ul style="list-style-type: none"> <li>• PORT mode: Select it when connecting in PORT mode.</li> <li>• PASV mode: Select it when connecting in PASV mode.</li> </ul>
Port No.*1	Set the control port No. of the FTP server. (21, 1024 to 65535)
Connection Command String	Set a command issued when the connection to the FTP server is established. A command is specified with one-byte characters and symbols. Up to 10 lines with 255 characters in each can be specified. The available commands depends on the FTP server. For details, check the manual of the FTP server.

\*1 The following are used for file transfer ports of the FTP server.

- In PORT mode: 20
- In PASV mode: Different depending on the FTP server.

## POINT

### PORT mode and PASV mode

#### (1) File transfer in PORT mode

1. A connection from the FTP client to the FTP server control port is made.
2. The file transfer port No. is notified from the GOT to the FTP server.
3. Using the notified port No., a request for data sending connection is sent from the FTP server to the FTP client.  
In this case, if the network is protected by a firewall, the connection from the FTP server is disabled.

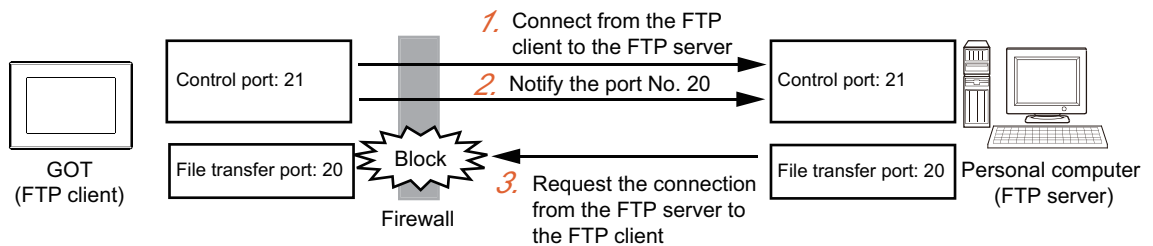

#### (2) File transfer in PASV mode

1. A connection from the FTP client to the FTP server control port is made.
2. The data transfer port No. is notified from the FTP server control port to the GOT (FTP client).
3. Using the notified port No., a request for data communication connection is sent again from the FTP client to the FTP server.  
In this case, the connection is available even if the network is protected by a firewall.

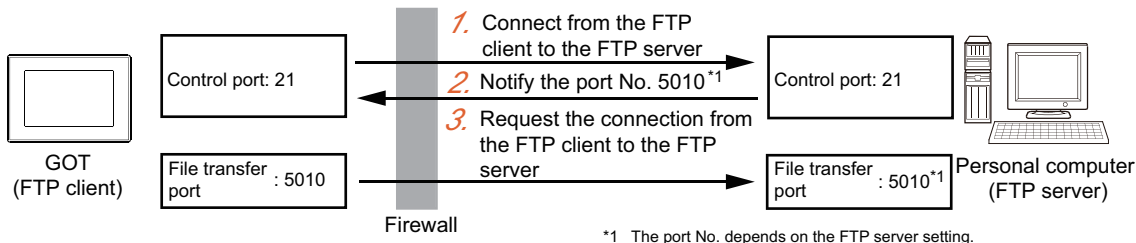

\*1 The port No. depends on the FTP server setting.



## File transfer setting dialog box

Item	Description			
File Transfer ID	Set an ID to specify the file transfer. (1~32767) Select a different number from that of another file transfer.			
Transfer Setting Name	Set the name of a file transfer setting. Up to 32 characters can be set in both one-byte and two-byte.			
Destination FTP Server ID	Set a destination FTP server setting ID for file transfer. ■ Destination FTP Server Setting dialog box			
File Transfer Direction	Set the file transfer direction. <ul style="list-style-type: none"> <li>• Write from GOT folder to FTP server folder</li> <li>• Read from FTP server folder to GOT folder</li> </ul>			
File Transfer Trigger	Set a trigger for executing the file transfer.			
	<table border="1"> <tr> <td>Trigger type</td> <td>Set a trigger type. (Rising/Falling/Sampling/ON Sampling/OFF Sampling).  (2) Operation after file transfer trigger conditions are satisfied.</td> </tr> <tr> <td>Trigger device</td> <td>When either rising, falling, ON sampling or OFF sampling is selected as the trigger type, set the bit device as the trigger device.  GT Designer3 Version1 Screen Design Manual (Fundamentals)</td> </tr> </table>	Trigger type	Set a trigger type. (Rising/Falling/Sampling/ON Sampling/OFF Sampling). (2) Operation after file transfer trigger conditions are satisfied.	Trigger device
Trigger type	Set a trigger type. (Rising/Falling/Sampling/ON Sampling/OFF Sampling). (2) Operation after file transfer trigger conditions are satisfied.			
Trigger device	When either rising, falling, ON sampling or OFF sampling is selected as the trigger type, set the bit device as the trigger device. GT Designer3 Version1 Screen Design Manual (Fundamentals)			
GOT Folder Name	Set the folder path used for sending and receiving files on the GOT (FTP client) side. A GOT folder name can be set in 0 to 76 one-byte alphanumeric characters and symbols. The folder division symbol "\" is not necessary in the end. A drive, B drive, D drive or E drive can be specified as the access destination. (D drive can be specified only for GT14 and E drive can be specified only for GT16 and GT14) When the GOT folder name is determined as blank, an access for "a:\" is made.			
	<table border="1"> <tr> <td>Specification</td> <td>Select a specifying method for the GOT folder name. <ul style="list-style-type: none"> <li>• Direct Select it when inputting the GOT folder name directly.</li> <li>• Device Select it when specifying a GOT folder indirectly with device.  (1) Indirect specification of folder name and file name</li> </ul> </td> </tr> </table>	Specification	Select a specifying method for the GOT folder name. <ul style="list-style-type: none"> <li>• Direct Select it when inputting the GOT folder name directly.</li> <li>• Device Select it when specifying a GOT folder indirectly with device.  (1) Indirect specification of folder name and file name</li> </ul>	
	Specification	Select a specifying method for the GOT folder name. <ul style="list-style-type: none"> <li>• Direct Select it when inputting the GOT folder name directly.</li> <li>• Device Select it when specifying a GOT folder indirectly with device.  (1) Indirect specification of folder name and file name</li> </ul>		
<table border="1"> <tr> <td>Folder Name</td> <td>When [Direct] is selected as the specifying method, set the folder name by inputting directly. When a GOT (FTP client) side folder is selected from the folder names that are already set in GT Designer3, click the [Folder List] button. Click it to display the [Folder List] dialog box. Select a save location folder name from the displayed list. *1  (3) Folder List dialog box</td> </tr> </table>	Folder Name	When [Direct] is selected as the specifying method, set the folder name by inputting directly. When a GOT (FTP client) side folder is selected from the folder names that are already set in GT Designer3, click the [Folder List] button. Click it to display the [Folder List] dialog box. Select a save location folder name from the displayed list. *1 (3) Folder List dialog box		
Folder Name	When [Direct] is selected as the specifying method, set the folder name by inputting directly. When a GOT (FTP client) side folder is selected from the folder names that are already set in GT Designer3, click the [Folder List] button. Click it to display the [Folder List] dialog box. Select a save location folder name from the displayed list. *1 (3) Folder List dialog box			

1

OVERVIEW

2

SYSTEM CONFIGURATION

3

GENERAL PROCEDURE TO BE FOLLOWED FOR USING

4

SERVER AND CLIENT FUNCTIONS

5

MAIL SEND FUNCTION

6



FTP SERVER FUNCTION

7

FILE TRANSFER FUNCTION (FTP CLIENT)

8

TROUBLE SHOOTING

Item	Description	
GOT Folder Name	Storage Device	When [Device] is selected as the specifying method, set the start device of the device which stores the GOT folder name. The number of sequential devices to be used is the number of [Maximum number of characters] of the set device divided by two. (The number is rounded up.)
	Maximum number of characters	Set the maximum number of characters of a GOT folder name. (8 to 76)
FTP Server Folder	Set the folder path used for sending and receiving files by the FTP server. An FTP server folder name can be set in 0 to 250 one-byte alphanumeric characters and symbols.* <sup>2</sup> (For GT15 or GT14, 0 to 100 characters) The folder division symbol "/" is not necessary in the end. When the folder name is determined as blank, an access for the default folder of the FTP server side is made.	
	Specification	Select a specifying method for the FTP server folder. • Direct Select it when inputting the FTP server folder directly. • Device Select it when specifying the FTP server folder indirectly with device.  (1) Indirect specification of folder name and file name
	Folder Name	When [Direct] is selected as the specifying method, set the folder name by inputting directly.
	Storage Device	When [Device] is selected as the specification method, set the start device of the device which stores the FTP server folder name. The number of sequential devices to be used is the number of [Maximum number of characters] of the set device divided by two. (The number is rounded up.)
	Maximum number of characters	Set the maximum number of characters of the FTP server folder name. (8 to 250)
Transfer File Name	Set a transfer file name. A transfer file name can be set in 1 to 75 one-byte alphanumeric characters and symbols. In addition, wild cards can be used for a transfer file name.  (4) Wild card specification of transfer files	
	Specification	Select a specifying method for the FTP server folder. • Direct Select it when inputting the transfer file name directly. • Device Select it when specifying the transfer file name indirectly with device.  (1) Indirect specification of folder name and file name
	File Name	When [Direct] is selected as the specifying method, set the transfer file name by inputting directly.
	Storage Device	When [Device] is selected as the specifying method, set the start device of the device which stores the transfer file name. The number of sequential devices to be used is the number of [Maximum number of characters] of the set device divided by two. (The number is rounded up.)
	Maximum number of characters	Set the maximum number of characters of the transfer file name. (8 to 75)
File Overwrite Specification	Set the operation when the transferred file has the same name as a file name in the transfer destination folder. • All Always overwrites files. • Updated files only Overwrites files only when the sending files are newer than files in the transfer destination folder or the time stamps are the same. In other cases, file transfer is not performed.	
Delete the source file after the transfer is completed	When this item is selected, the source file is deleted after the transfer is completed.	

\*1 Contents selected in the [Folder List] dialog box are reflected only in [GOT Folder Name].  
They are not reflected in [Transfer File Name].

\*2 The maximum number of characters and available characters depend on the FTP server specifications.  
Check the manual of the FTP server you use before setting.

**POINT**

**(1) FTP server folder and transfer file name**

Set the total number of characters of the FTP server folder and transfer file name within the following. If the total number of characters exceeds the following, an error occurs.

- When using GT16: 250 characters
- When using GT15 or GT14: 100 characters

Configure the FTP server folder path with one-byte alphanumeric characters and symbols. If two-byte characters are used, the file cannot be transferred.

**(2) Setting of file overwrite specification**

Select [All] to always send the latest files to the FTP server.

To transfer only updated files from the log files collected by logging, select [Updated files only].

Files can be transferred effectively since the files which were already transferred are not sent again.

**(1) Indirect specification of folder name and file name**

When [Device] is set as the specifying method of the folder name or file name, the GOT folder name or file name is stored in the sequential devices whose number is [Maximum number of characters] divided by two with having the specified device on the top.

(The number is rounded up.)

Store the folder name or file name in the device in order from lower to higher in the ASCII code.

In addition, store Null (0x00) in the end of the folder name.

Example: When the "ftpclient1" folder in the A drive is specified

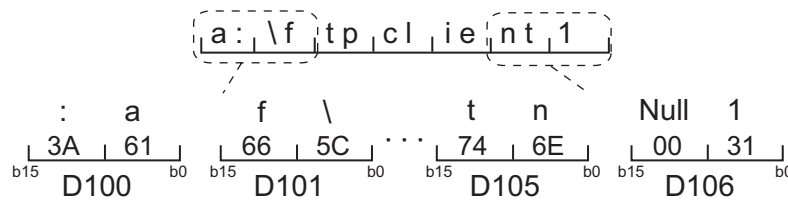

**(2) Operation after file transfer trigger conditions are satisfied.**

The following shows the operation until the file transfer when two file transfer trigger conditions are satisfied in series.

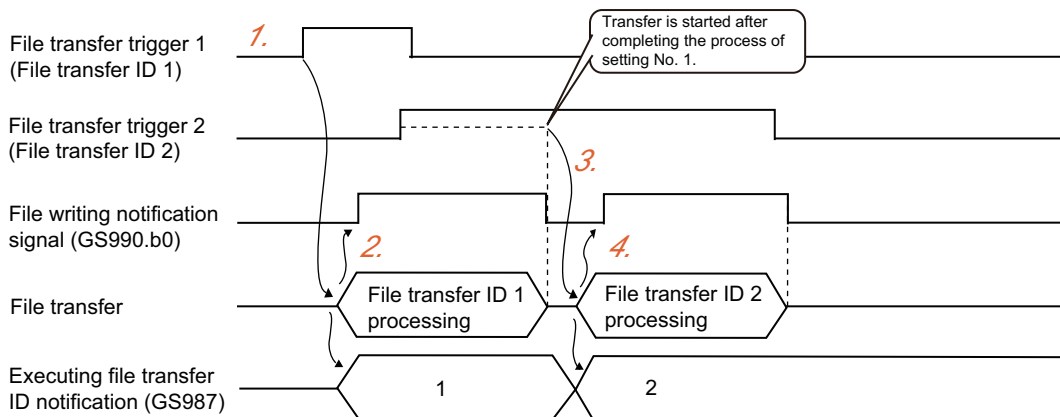

1. As a file transfer trigger condition of the file transfer ID 1 is satisfied, the GOT starts file transfer of the file transfer ID 1.
  2. As the GOT starts file transfer of the file transfer ID 1, the file writing notification signal (GS990.b0) turns ON and 1 is stored in the executing file transfer ID notification.
  3. While a file writing notification signal is ON, the GOT does not start file transfer even when a file transfer trigger condition of the file transfer ID 2 is satisfied.  
When the file transfer of the file transfer ID 1 is completed, the file writing notification signal turns OFF.  
When the file writing notification signal turns OFF, the file transfer of the file transfer ID 2 is started.
  4. As the GOT starts file transfer of the file transfer ID 2, (GS990.b0) turns ON and 2 is stored in the executing file transfer ID notification.  
When the file transfer of the file transfer ID 2 is completed, the file writing notification signal turns OFF.
- (a) File transfer trigger when starting a GOT  
When starting a GOT, if the trigger type of the file transfer trigger is [Rising] and a trigger device is ON in advance, the trigger condition is satisfied.  
When the trigger type is [Falling] and the trigger device is OFF in advance, the trigger condition is also satisfied.
- (b) File transfer trigger condition satisfied during file transfer  
A file transfer trigger condition satisfied during file transfer is processed as following.
- Trigger of identical file transfer settings:  
Satisfaction of the file transfer trigger condition is ignored.
  - Trigger of different file transfer settings:  
As the file transfer trigger condition is satisfied, the file is transferred after the previous file is transferred.  
When multiple trigger conditions are satisfied during file transfer, the files are transferred in the order of the file transfer setting ID.

**(3) Folder List dialog box**

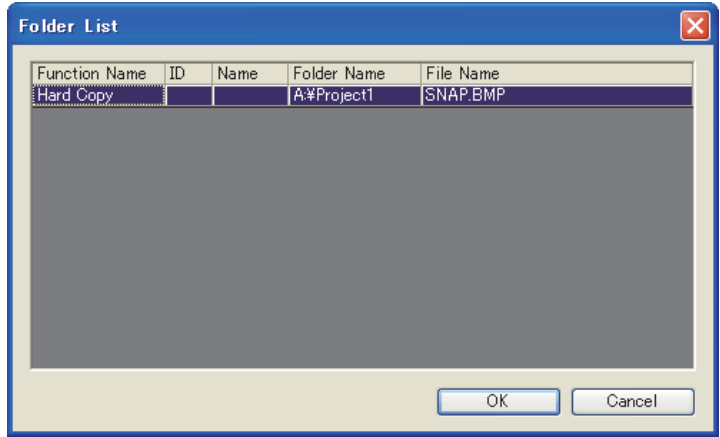

Item	Description
Function Name	Displays the name of the function which saves the file.
ID	Displays the setting ID set in each function. (Example. Alarm ID, in the case of extended function alarm observation) This space is blank when the function has no setting ID.
Name	Displays the setting name set in each function. (Example. Alarm name, in the case of extended function alarm observation) This space is blank when the function has no setting name.
Folder Name	Displays the file save destination.
File Name	Displays the name of the file stored in the save folder.

**POINT**

**Functions displayed in the Folder List dialog box**

If the following functions are set in the project, the folder names of the file save folders set in each function are displayed in the [Folder List] dialog box.

Function Name
Advanced user alarm observation, advanced system alarm observation, alarm history, logging, advanced recipe, recipe, operation log, hard copy

**(4) Wild card specification of transfer files**

Use the wild card with the following conditions:

- (a) The only symbol that can be used as a wild card is "\*".  
Example of enabled use: "ARP\*.DAT"  
Example of not enabled use: "ARP?????.DAT"
- (b) Only one "\*" can be used.  
However, "/\*.\*" only can be used as an exception.  
Example of enabled use: "/\*.DAT"  
Example of not enabled use: "ARP\*.\*"
- (c) When using "\*" in the file name part, it only can be used immediately before "." (period).  
Example of enabled use: "ARP\*.DAT"  
Example of not enabled use: "ARP\*01.DAT"
- (d) When using "\*" in the file name extension part, it only can be used with the wild card singularly.  
Example of enabled use: "ARP00001.\*"  
Example of not enabled use: "ARP00001.\*AT"

## 7.3.2 FTP server setting

---

The setting of the FTP server depends on the FTP server used.

Refer to the followings, according to the equipment used, and perform the settings.

- Personal computer, etc.

 Manual of the FTP server used

- GOT (FTP server)

 6.3 Setting Method

## 7.4 Confirmation of Processing Status

The file transfer function (FTP client) enables the confirmation of the file transfer processing status and occurred errors by the GOT special register (GS).

### ■ Read device

Device	Name		Description
GS401	FTP communication control		Controls the FTP communication.
	b0	FTP communication error clear signal	Use this for the recovery of FTP communication error. When turned ON, the FTP communication error notification signal (GS990.b15) turns OFF.
GS402	FTP communication timeout time		Set the time period before a timeout occurs during the FTP communication. The default is 3 seconds. The setting range is from 1 to 300 seconds. If the device value is set to 0, or 301 or more, the value is determined to be 3 seconds.

### ■ Write device

Device	Name		Description	
GS401	FTP communication control		Controls the FTP communication.	
	b0	FTP communication error clear signal	Turns ON to clear error signals generated in the FTP communication. The signals below turn OFF by turning ON the FTP communication error clear signal. <ul style="list-style-type: none"> <li>Warning notification signal (GS990.b14)</li> <li>FTP communication error notification signal (GS990.b15)</li> </ul>	
GS987	Executing file transfer ID notification		Stores the file transfer setting ID of the file transfer setting in execution.	
GS988	Communicating FTP server ID notification		Stores the FTP server setting ID of the currently connected destination FTP server setting.	
GS989	FTP communication error No. notification		Stores the error code at FTP communication error occurrence.  8.6.1 Error codes and error messages	
GS990	FTP communication status notification		Notifies the FTP communication status to the user.	
	b0	File writing notification signal	Turns ON when GOT (FTP client) writes files into the FTP server.	
	b1	File reading notification signal	Turns ON when GOT (FTP client) reads files from the FTP server.	
	b2	FTP server connection mode notification signal	Notifies the connection mode of GOT (FTP client) and FTP server. ON : Connected in PASV mode. OFF : Connected in PORT mode.	
	b14	Warning notification signal	Turns ON if errors with which the processing can be continued occur during the file transfer. This signal can be turned OFF by turning ON the FTP communication error clear signal (GS401.b0)	
GS991	FTP transfer target file count notification	b15	FTP communication error notification signal	Turns ON if errors with which the processing cannot be continued occur during the file transfer. Files cannot be transferred while this signal is turned ON. This signal can be turned OFF by turning ON the FTP communication error clear signal (GS401.b0).
		Stores the total number of files to be transferred. When a wild card is specified, files which are not transferred due to an invalid number of characters of folder names or other reasons are also counted. (However, only files which have unusable names, such as two-byte characters, are not counted.) Holds the device value until the next file transfer ID is processed.		
GS992	FTP transfer completion file count notification		Stores the total number of files which the transfer is completed. Files which are not transferred due to an error or other reasons are also counted. Holds the device value until the next file transfer ID is processed.	

## 7.5 Examples of Use

The following gives the examples of using the file transfer function (FTP client).

### ■ Sending the alarm log file

Alarm log files collected by GOT are converted to CSV format files and transferred to the FTP server.

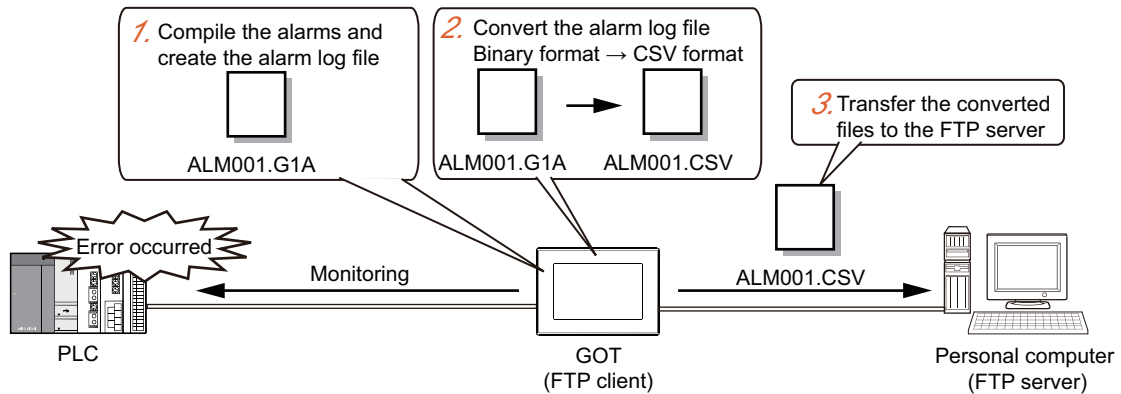

1. The GOT creates an alarm log file based on the collected alarm data.
2. Convert the alarm log files from the binary format to the CSV format.
3. Transfer the converted files to the FTP server.

#### (1) Setting

The following shows the required settings.  
Make settings other than the below arbitrarily.

##### (a) Settings of advanced alarm

Setting	Description	Reference
Advanced alarm common setting	Convert trigger device	Set an arbitrary bit device.
	Convert-in-motion notification device	
Advanced user alarm observation	[Basic] tab	Set the history collection method. Select either [Historical] or [Cumulative].
	[Device] tab	Set an observation target device.
	[File Save] tab	Check [Save alarm log files], and set the log file save destination and the storage trigger. Select [Rise] as the trigger type of the storage trigger.
		GT Designer3 Version1 Screen Design Manual (Functions)

##### (b) Settings of file transfer function (FTP client)

Setting	Description	Reference
Destination FTP Server Setting	Set an arbitrary FTP server.	7.3.1 ■ Destination FTP Server Setting dialog box
File Transfer Setting	File transfer trigger	Set [Rise].
	Transfer File Name	Set the alarm log file name specified in the advanced alarm observation.
		7.3.1 ■ File transfer setting dialog box

##### (c) GOT special register (GS)

The following GOT special registers are used.

Device	Description	Reference
GS990.b0	File writing notification signal	7.3.2 ■ Write device



**(2) Operation**

The following shows the operation after creating the alarm log file, from the alarm log file conversion to the transfer.

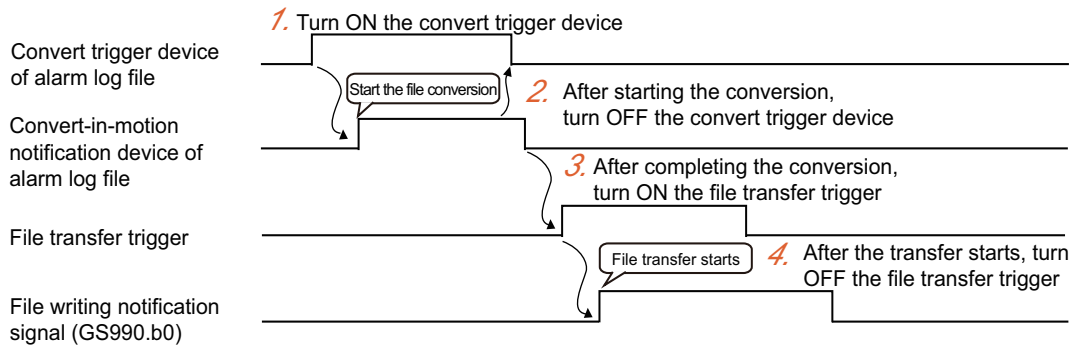

1. Turn ON the convert trigger device of the alarm log file.  
The GOT starts converting the files, and the convert-in-motion notification device turns ON.
2. After starting the file conversion, turn OFF the convert trigger device.  
When the file conversion is completed, the convert-in-motion notification device turns OFF.
3. Turn ON the file transfer trigger.  
The GOT starts transferring the files, and the file writing notification signal (GS990.b0) turns ON.
4. After starting the file transfer, turn OFF the file transfer trigger.  
When the file transfer is completed, the file writing notification signal (GS990.b0) turns OFF.



**Turning file transfer trigger ON automatically**

In the example above, the file transfer trigger should be turned ON by the user after the file conversion is completed. In addition, the convert trigger device and file transfer trigger of the alarm log file should also be turned OFF by the user, after the processing is started. By using two project scripts, those operations can be automated. The following shows examples of setting.

(1) Device to be used

Device name	Device number	Script to use the device
Convert-in-motion notification device of alarm log file	GB100	Script No.1
Trigger device of script No.1		
Convert trigger device of alarm log file	GB105	Script No.1
File transfer trigger	GB110	Script No.1, Script No.2
File writing notification signal	GS990.b0	Script No.2
Trigger device of script No.2		

(2) Setting of project script

- (a) Script No.1  
Set [Rise] for the trigger type.  
Use the same trigger device as the convert-in-motion notification device of the alarm log file.
- (b) Script No.2  
Set [Rise] for the trigger type.  
As for the trigger device, use the file writing notification signal (GS990.b0).

(3) Script

- (a) Script No.1  
set([b:GB110]); // File transfer trigger ON  
rst([b:GB105]); // Alarm log file convert trigger OFF
- (b) Script No.2  
rst([b:GB110]); // File transfer trigger OFF

## 7.6 Precautions

The following are precautions when using the file transfer function (FTP client).

### ■ Precautions for system design using the file transfer function (FTP client)

#### (1) Port No. overlap

Check if the port No. used in the FTP communication is not used in the connection with other equipment, etc. If an overlapped port No. is set, the communication with the FTP server may fail, or unexpected operations may occur in other equipment.

#### (2) Transfer file time stamp

As for the transfer file time stamp, the time on the FTP server at the completion of writing into the transfer destination folder is recorded.

Some FTP server cannot acquire a transfer file time stamp.

In this case, transfer files are always overwritten regardless of the setting in [File Overwrite Specification].

#### (3) Time on the GOT (FTP client) and FTP server

When [Updated files only] is selected in the file overwrite specification, set the same time on the GOT (FTP client) as that on the FTP server.

As for the transfer file time stamp, the time at the completion of transferring into the transfer destination folder is recorded.

Therefore, if the times on the GOT (FTP client) and FTP server are different, the transferred file may be regarded as an older file than the file transferred last time even the source file is the latest.

In this case, the file is not transferred.

Example: When a difference between two times of GOT (FTP client) and personal computer (FTP server) is 20 minutes

#### 1. A file created at 10:00 is transferred.

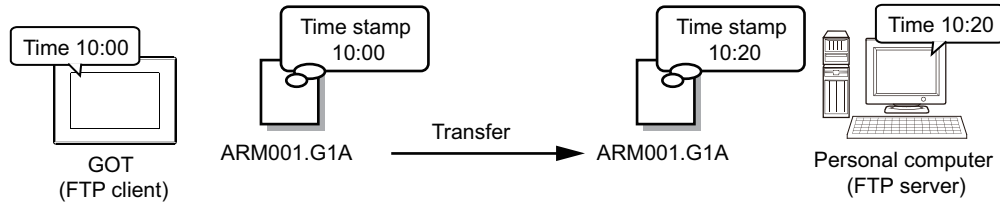

#### 2. The time stamps of the file created at 10:10 and the file in the FTP server are compared.

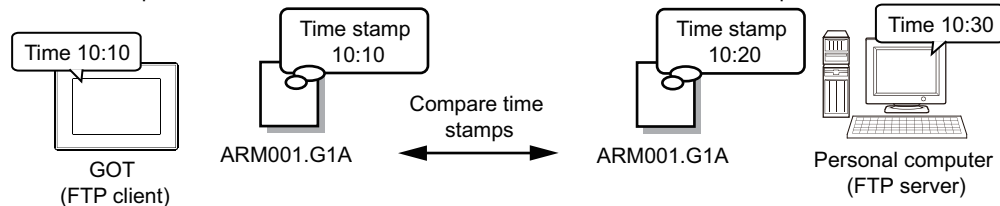

#### 3. The file is not transferred since it is regarded as an old file.

Select [All] in the file overwrite specification if there is a time difference between the install location of the GOT (FTP client) and FTP server.

If there is a time difference between the installation locations, time stamps cannot be compared properly since the time on the GOT and FTP server may differ even the times are set correctly.

#### (4) Indication in the file list of the FTP server

The GOT (FTP client) is compatible with the FTP servers that use alphanumeric characters to show the date and time information of the files in the file list.

If an FTP server uses characters other than alphanumeric characters such as Japanese kanji in the file list, the files cannot be transferred.

Configure the settings including the OS setting on the FTP server so that the FTP server uses alphanumeric characters to show the information in the file list.

To check the file list of the FTP server, issue a `dir` command or a `list` command in the command prompt on a personal computer that is connected to the FTP server.

Example 1) When the FTP server uses alphanumeric characters in the file list  
The FTP server is compatible with the GOT (FTP client).

```
02-08-14 05:30PM          348000 sample1.txt
11-02-15 10:30AM          234000 sample2.txt
:
```

Example 2) When the FTP server uses alphanumeric characters in the file list  
The FTP server is compatible with the GOT (FTP client).

```
-rwxrwxrwx 1 owner  group   348000 Feb 8 17:30 sample1.txt
-rwxrwxrwx 1 owner  group   234000 Nov 2 10:30 sample2.txt
:
```

Example 3) When the FTP server uses Japanese kanji characters in the file list  
The FTP server is incompatible with the GOT (FTP client).

```
-rwxrwxrwx 1 owner  group   348000 2月 8日 17:30 sample1.txt
-rwxrwxrwx 1 owner  group   234000 11月 2日 10:30 sample2.txt
:
```

### ■ Precautions for file transfer

#### (1) GOT (FTP client) side folder path and transfer file name

Set the GOT (FTP client) side folder path within 78 characters, including the transfer file name.  
If the total number of characters exceeds 78, an error occurs.

#### (2) FTP server folder path and transfer file name

Set the total number of characters of the FTP server folder and transfer file name within the following.  
If the total number of characters exceeds the following, an error occurs.

- For GT16: 250 characters
- For GT15 or GT14: 100 characters

Configure the folder path with one-byte alphanumeric characters and symbols.  
If two-byte characters are used, the file cannot be transferred.

#### (3) Warning error of when the file name is specified by wild card

If file names are specified by wild card, a warning error may occur when the files are transferred.  
The warning error does not interrupt the next file transfer.

In this case, the file transfer may fail because the transfer file name is invalid or writing to transfer destination folder is inhabited.

Transfer the files again after checking the error code stored in FTP communication error No. notification (GS989) and clear those problems.

 8.6.1 Error codes and error messages

#### (4) Offline status of GOT

When GOT goes offline during a file transfer, the file transfer is interrupted.

Do not perform operations which make the GOT offline, such as communication with GT Designer3, during the file transfer.

**(5) Deleting source files after the completion of the transfer**

When the source file is set to be deleted after the completion of the transfer in [File Transfer Setting], pay attention to the following.

(a) Deleting files referred from GOT

Do not delete files which are referred from GOT, such as logging files, from the GOT folder.

If they are deleted, data cannot be browsed on GOT.

(b) Setting of the transfer file name using wild card specification

If files which should not be deleted are in the source folder, do not specify the transfer file name by wild card specification.

If the names of transfer file are specified by wild card, necessary files may be deleted involuntarily.

**(6) Corrective actions after FTP communication error**

After the occurrence of FTP communication error, turn ON the FTP communication error clear signal (GS401.b0) at the user.

When the FTP communication error clear signal is turned ON, the FTP communication error notification signal (GS990.b15) turns OFF.

While the FTP communication error notification signal is turned ON, the status is considered to be in FTP communication error occurrence.

During FTP communication error occurrence, the next file transfer cannot be performed.

**(7) Using the recipe file as the transferring recipe**

When change (rewrite) the contents of the recipe file, make the recipe inactive.

If the recipe file in the memory card is deleted during recipe processing, the function will not operate properly.

If the recipe file is deleted at a time other than during recipe processing, an error (system alarm: recipe file error) will occur in the next recipe operation.

**(8) Power OFF during access to memory card or USB memory**

Do not turn the GOT power OFF during access from the FTP server to the GOT memory card or to files in the USB memory.



Data in the memory card or USB memory may be damaged.

# 8. TROUBLESHOOTING

This chapter details the troubleshooting of the gateway functions.

## 8.1 Troubleshooting Common to Gateway Functions

The following troubleshooting common to the gateway functions:

Phenomenon	Definition and Cause	Corrective Action
GOT can not communicate with the controller.	Mounting of a communication unit, the OS installed to a GOT, communication setting, and the like are incorrect.	Check the mounting of a communication unit, the OS installed to the GOT, communication setting, and the like following the procedure explained in the GOT1000 Series Connection Manual.  GOT1000 Series Connection Manual for GT Works3 and a controller used)
The gateway functions do not work.	At no response for ping test while all bits of GS200 are OFF.*1, *2	Option OS of the gateway functions is not installed in the GOT.  GT Designer 3 Version1 Screen Design Manual (Fundamentals))
		The option function board is not mounted. Mount the option function board.
		The IP address is not set to the GOT main unit. Check if the IP address has been set to the GOT main unit, using the utility function.
	Port No. setting of the personal computer (MX Component) differs from the GOT port No. (5011). Check the Port No. setting of the personal computer (MX Component) if it is identical to the GOT port No. (5011).	
With response for ping test while any bit of GS200 is ON.*1, *2	-	Take the corrective action, referring to the troubleshooting of the function corresponding to the bit that is ON.  8.2 Gateway Information)

\*1 Refer to the following for details of the gateway common information (GS200).

 8.2 Gateway Information

\*2 Use either of the following methods to check whether or not response is given to Ping.  
Execute the Ping command from the personal computer to the GOT.  
Execute the "PING TEST" provided by GT Designer 3.

 GOT1000 Series Connection Manual for GT Works3 and a controller used

## 8.2 Gateway Information

The error information of the gateway functions is stored in the special registers (GS) of a GOT.  
It is possible to check the error information of the gateway functions by monitoring the GOT special registers.  
Refer to the following manual for details of the GOT special registers.

 GT Designer 3 Version1 Screen Design Manual (Fundamentals)

### ■ Gateway function error information table



#### (1) Read device

Device	Function	Description
GS400	Gateway common information	 (a) Gateway common control (GS400)

#### (a) Gateway common control (GS400)

b15	b14	b13 to b12	b11	b10 to b9	b8	b7 to b3	b2	b1 to b0
b1 to b0 : Reserved								
b2 : Forcibly logs the FTP server function out. ( : areas are reserved.)								
<input type="checkbox"/> <input type="checkbox"/> : 4 <sub>H</sub> : Forced logout								
b7 to b3 : Reserved								
b8 : Enables reading of a binary format file (*.G1 <input type="checkbox"/> ) from an FTP client when this bit is turned ON. Note that reading of the following binary format files is not allowed.								
<ul style="list-style-type: none"> <li>• *.G1</li> <li>• *.G1D</li> </ul>								
b10 to b9 : Reserved								
b11 : Clears the error (G200.b11, GS201 to GS206) of the mail send function when this bit is turned ON. ( : areas are reserved.)								
<input type="checkbox"/> <input type="checkbox"/> : 8 : Clears the mail send function error.								
b13 to b12 : Reserved								
b14 : Clears the error (G200.b14, GS210 to GS216) of the server function when this bit is turned ON. ( : areas are reserved.)								
4 <input type="checkbox"/> <input type="checkbox"/> : Clears the server function error.								
b15 : Clears the error (G200.b15, GS220 to GS226) of the client function when this bit is turned ON. ( : areas are reserved.)								
8 <input type="checkbox"/> <input type="checkbox"/> : Clears the client function error.								

## (2) Write device

Device	Function	Description	
GS200	Gateway common information	 (a) Gateway common information (GS200)	
GS201	Mail send function	Error counter	
GS202		Error code	
GS203		Date and time of occurrence	Stores the year (upper byte, 2 lower digits of year) and the month (lower byte) of the error occurrence date/time in BCD code.
GS204			Stores the day (upper byte) and the hour (lower byte) of the error occurrence date/time in BCD code.
GS205			Stores the minute (upper byte) and the second (lower byte) of the error occurrence date/time in BCD code.
GS206		Mail send destination	 (b) Mail send source of mail send function (GS206)
GS207 to GS209		Reserved	-
GS210	Server function	Error counter	
GS211		Error code	
GS212		Date and time of occurrence	Stores the year (upper byte, 2 lower digits of year) and the month (lower byte) of the error occurrence time in BCD code.
GS213			Stores the day (upper byte) and the hour (lower byte) of the error occurrence time in BCD code.
GS214			Stores the minute (upper byte) and the second (lower byte) of the error occurrence time in BCD code.
GS215		Request source	Stores the lower part of the IP address of the GOT (client) where the error occurred in BIN code.
GS216			Stores the upper part of the IP address of the GOT (client) where the error occurred in BIN code.
GS217 to GS219		Reserved	-
GS220	Client Function	Error counter	
GS221		Error code	
GS222		Date and time of occurrence	Stores the year (upper byte, 2 lower digits of year) and the month (lower byte) of the error occurrence time in BCD code.
GS223			Stores the day (upper byte) and the hour (lower byte) of the error occurrence time in BCD code.
GS224			Stores the minute (upper byte) and the second (lower byte) of the error occurrence time in BCD code.
GS225		Request destination	Stores the lower part of the IP address of the GOT (server) where the error occurred in BIN code.
GS226			Stores the upper part of the IP address of the GOT (server) where the error occurred in BIN code.
GS227 to GS229		Reserved	-

### (a) Gateway common information (GS200)

b15	b14	b13 to b12	b11	b10 to b5	b4	b3	b2	b1	b0
-----	-----	------------	-----	-----------	----	----	----	----	----

- b0 : ON while the mail send function is ready.
- b1 : ON while the FTP server function is ready.
- b2 : Turns on when an FTP client logs in.
- b3 : ON while the server function is ready.
- b4 : ON while the client function is ready.
- b10 to b5 : Reserved
- b11 : Turns ON when an error occurs in the mail send function.
- b13 to b12 : Reserved
- b14 : Turns ON when an error occurs in the server function.
- b15 : Turns ON when an error occurs in the client function.

### (b) Mail send source of mail send function (GS206)

b15 to b2	b1	b0
-----------	----	----

- b0 : Reserved
- b1 : Turns ON when an alarm occurs in the alarm history.
- b15 to b2 : Reserved

1 OVERVIEW  
2 SYSTEM CONFIGURATION  
3 GENERAL PROCEDURE TO BE FOLLOWED FOR USING  
4 SERVER AND CLIENT FUNCTIONS  
5 MAIL SEND FUNCTION  
6 FTP SERVER FUNCTION  
7 FILE TRANSFER FUNCTION (FTP CLIENT)  
8 TROUBLE SHOOTING

## 8.3 Server and Client Functions

### 8.3.1 Error codes and error messages

#### ■ GOT error code table

The following table details the error codes that are stored in the GOT special registers, GS211 (server function error codes) and GS221 (client function error codes):

Error Code <sup>*1</sup>	Definition and Cause	Corrective Action
490	Monitor the gateway device of the GOT (where a script program is running) by the script function.	<ol style="list-style-type: none"> <li>1. Change the monitor destination GOT specified in the script to other GOT.</li> <li>2. Monitor the PLC CPU devices directly without using the script.</li> </ol>
491	Access a station that does not exist.	Check the network No., PLC station No. and Ethernet settings of the monitor destination.
492	A communication time error occurred.	<ol style="list-style-type: none"> <li>1. Increase the value set for "Timeout time" in the utility of the GOT.</li> <li>2. Check the network. (Check the presence/absence of the firewall, execution of Ping, for example.)</li> <li>3. Check for cable disconnection and check the unit mounting status.</li> <li>4. Check the network. (Check the presence/absence of the firewall, execution of Ping, for example.)</li> </ol>
493	A communication error occurred.	<ol style="list-style-type: none"> <li>1. Check for cable disconnection and check the unit mounting status.</li> <li>2. Check the network. (Check the presence/absence of the firewall, execution of Ping, for example.)</li> </ol>

\*1 In the GOT (server), only the error of error code 493 occurs.

#### POINT

##### (1) If error code 493 occurred in the GOT (server)

This error may occur when the traffic of the network is heavy.

If no error has occurred in the target GOT (client), it poses no specific problem since normal communication is restored by the retry processing of the GOT (client).

##### (2) If error code 493 occurred in the system that uses a router

If error code 493 occurred in the GOT (server), the router address is taken as the IP address of the target client.

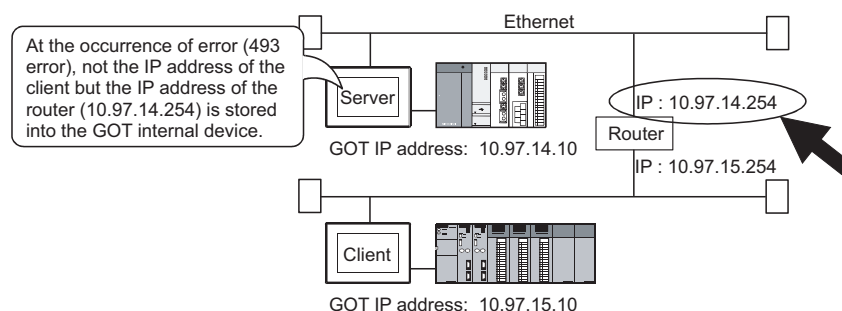

##### (3) If an error occurred in the GOT (client)

The script stops if an error occurs in the GOT (client). If an error occurred in the GOT, take the corrective action and execute the script again.

Refer to the following manual for details of the script function.

GT Designer 3 Version1 Screen Design Manual (Fundamentals)

##### (4) If error code 492 occurred in the GOT (client)

This error may occur when there are many GOTs (client) that access the GOT (server). Adjust the value set for "time-out time".

(As a guideline, set the value of "Present time-out time" × "Number of GOTs (client)".)



**(5) If error code 15 (script has not completed after the elapse of script monitoring time) was stored to the script error data (GS16 to GS47) when the script that used gateway devices was used**

This error may occur when there are many GOTs (client) that access the GOT (server).

Adjust the value set for "script monitoring time" (GS385).



(As a guideline, set the value of "Present script monitoring time" × "Number of GOTs (client)".)

Refer to the following manual for details of the script function.

 GT Designer 3 Version1 Screen Design Manual (Fundamentals)

## ■ MX Component error code table

The following table details the error codes that may occur when access is made from MX Component to a GOT:

Error Code <sup>*1</sup>	Definition and Cause	Corrective Action
0x0180840B	Time-out error Data could not be received after the elapse of time-out time.	<ol style="list-style-type: none"> <li>Corrective action for MX Component <ul style="list-style-type: none"> <li>Review the time-out value of the property.</li> <li>Set it again on the communication settings utility.</li> <li>Review the system, e.g. PLC CPU, module setting and cable status.</li> <li>Retry the method.</li> <li>Perform Close once and execute Open again.</li> <li>Exit the program and restart the IBM-PC/AT compatible.</li> </ul> </li> <li>Corrective action for GOT <ul style="list-style-type: none"> <li>Check if the server setting of GT Designer 3 has been made.</li> </ul> </li> </ol> <p> MX Component Version3 Programming Manual</p> <p> 4.4 Setting Method)</p>
0x010F4030	An unusable device or a device that does not exist is assigned to the accessed gateway device.	In the server setting of GT Designer 3, check if the device assignment is correct or if the set device exists.
0x010F4031	A PLC device outside the monitor range is assigned to the accessed gateway device.	In the server setting of GT Designer 3, check if the device within the monitor range is assigned.
0x010F4B00	Communication time-out occurred. The unit is not mounted correctly or the cable is not connected correctly.	<ol style="list-style-type: none"> <li>Check for cable disconnection, and check the communication unit mounting status and the PLC status.</li> <li>This error may occur when the PLC load increases during access to other station. If this error occurred, move the data of other station to the host PLC and monitor the data at the host.</li> <li>If the sequence scan time is long, insert the COM instruction.</li> <li>Check the GOT error codes of the alarm list display function (system alarm) and system information. If an error has occurred, take the corresponding corrective action.<sup>*2</sup></li> </ol>

\*1 If an error code other than those indicated above occurred, refer to the following manuals.

 MX Component Version 3 Operating Manual



MX Component Version 3 Programming Manual

\*2 Refer to the following manual for details of GOT error codes.

 User's Manual for the GOT used

## 8.3.2 Troubleshooting

The following table details the troubleshooting for use of the server and client functions:

Phenomenon	Definition and Cause	Corrective Action
Gateway devices cannot be monitored.	In the server setting, a device that does not exist is assigned to the gateway device to be monitored.	Check the controller device assigned to the gateway device.
	In the client setting, the IP address of the GOT to be monitored is incorrect.	Check the IP address of the GOT to be monitored.
	An error occurred in the GOT of the server function or the client function.	Check the GOT special registers, GS211 and GS221, and take the corrective action.  8.3.1 Error codes and error messages)
	A script function error occurred.	Check the script function error and take the corrective action.  GT Designer 3 Version1 Screen Design Manual (Functions)

## 8.4 Mail Send Function

### 8.4.1 Error codes and error messages

The following table details the error codes stored in the GOT special register GS202 (mail send function error code):

Error code	Definition and Cause	Corrective Action
2	The FROM address has not been set.	Set FROM. (Mail send setting on GT Designer 3)
3	The SMTP server has not been set.	Set the SMTP server (Mail send setting on GT Designer 3)
4	The send destination address has not been set.	Set the send destination (TO). (Mail send setting on GT Designer 3)
5	The mail address is incorrect.	Check whether the mail address settings of FROM, TO, CC and BCC are correct. Check whether the double-byte is not used. (Mail send setting on GT Designer 3)
6	Alarms exceeding the limit of send processing capacity may have occurred.	Check the number of alarms that have occurred. (The maximum number of alarms that can be sent by mail at a time is 16.)
10	The SMTP server could not be connected.	1. Check whether the SMTP server is abnormal. 2. Check whether the IP address setting of the SMTP server is correct or not. (Mail send setting on GT Designer 3) 3. Ask the network administrator about the router address and subnet mask, and set them in the setup of the GOT. 4. When a firewall is installed on the network, ask the network administrator if port 25 is opened.
11	Time-out occurred when establishing connection to the SMTP server.	1. Check whether the SMTP server is normal or not. 2. Increase the value set for "Time-out time" (Utility of GOT).
12	Error notification is given from the SMTP server.	1. Check whether the SMTP server is normal or not. 2. Ask the network administrator if mail can be sent without authentication, such as POP3 authentication.

### 8.4.2 Troubleshooting

The following table details the troubleshooting for use of the mail send function:

Phenomenon	Definition and Cause	Corrective Action
Mail cannot be sent.	The SMTP server is not operating properly.	Ask the network administrator if the SMTP server is operating properly.
	FROM (send source) is not set correctly.	Check if the FROM is set correctly.
	An attempt was made to send 17 or more mails at a time.	Reduce the number of mails to be sent at a time to 16 or less.
The mail send time is incorrect.	The set time of the SMTP server is incorrect. (The GOT sends the mail using the clock of the SMTP server.)	Check if the clock of the SMTP server is correctly set.
Texts being sent/received by a cellular phone is broken midway.	The number of characters that can be sent/received by a cellular phone was exceeded.	Reduce the number of characters in texts to be sent by mail to within the number of characters that can be sent/received by the cellular phone to be used.
One-byte katakana cannot be displayed.	One-byte katakana cannot be used in text to be sent. It is changed to two-byte character.	The phenomenon is normal.



## 8.5.2 Troubleshooting

The following table describes troubleshooting when using the FTP server function.

Phenomenon	Error contents and cause	Corrective action
Line cannot be connected.	[Use FTP Function] is not checked in the FTP server setting of GT Designer2.	Check [Use FTP Function].
	Another device has logged into the GOT.	After the other device has logged out, connect the line again.
	–	Issue the ping command to the GOT and check for a reply.
	–	Confirm with the network administrator.
Cannot login.	The login name or password is incorrect.	Enter the correct login name or password. (Case sensitive)
File cannot be written.	The file name is not recognized by the GOT.	Refer to the following manual for the file names that can be set.  6.4.2 File specifying method
	The reference mode is selected.	Change to the write mode.
	Overwrite disable or a similar setting has been made to the FTP client setting.	Review the FTP client setting.
	A file with the same name already exists.	Delete the file or change the file name to a name that does not exist.
	The memory card is write-protected.	Cancel the write protection of the memory card.
	The CF card access switch of the GOT main unit is off.	Turn the CF card access switch of the GOT main unit off.
File cannot be read.	An attempt was made to read a file that does not exist.	Check for the file using the dir or ls command.
	The CF card access switch of the GOT main unit is off.	Turn the CF card access switch of the GOT main unit on.
File cannot be deleted.	The memory card is write-protected.	Cancel the write protection of the memory card.
	The CF card access switch of the GOT main unit is off.	Turn the CF card access switch of the GOT main unit on.
GOT has been powered off during login.	–	Delete the file being transferred without using it since it may have been corrupted. (The operation of the FTP client changes depending on the specifications of the FTP client.)
FTP client software has been forcibly exited during login.	–	Login to the GOT again after the time set to the watching timer of command input in the FTP server setting has elapsed. (The GOT logs out after the time set to the command has elapsed.)

## 8.6 File Transfer Function (FTP Client)

### 8.6.1 Error codes and error messages

The following table details the error codes that are stored in the GOT special registers, GS989 (FTP communication error code notification):

Error code	Definition and Cause	Corrective Action
1	Connection to the FTP server failed.	<ul style="list-style-type: none"> <li>• Check the IP address of the FTP server.</li> <li>• Check if the cable is not disconnected or broken.</li> <li>• Check HUB connection status.</li> <li>• Check if the FTP server is operating on the target device.</li> <li>• Check if there is any error in the connected FTP server setting.</li> </ul>
2	Authentication of the FTP server failed.	<ul style="list-style-type: none"> <li>• Check if there is any error in the user name and password.</li> </ul>
3	FTP server Busy	<ul style="list-style-type: none"> <li>• Wait until the Busy status of the FTP server is canceled.*1</li> </ul>
4	FTP communication timeout	<ul style="list-style-type: none"> <li>• Check if the communication line is not physically broken.</li> <li>• Check the connection congestion.</li> </ul>
5	Access to the file for writing failed.	<ul style="list-style-type: none"> <li>• Check if the writing destination drive is valid.</li> <li>• Check if there is available space enough in the writing destination drive.</li> <li>• Check if the write inhibit is not set to the file.</li> <li>• When using the GOT as the FTP server, check if the write enable mode is set.</li> </ul>
6	Access to the file for reading failed.	<ul style="list-style-type: none"> <li>• Check if the target file for reading exists.</li> <li>• Check whether the file name specified by the file transfer setting is correct or not.</li> <li>• Check if the memory card is installed on the GOT.</li> <li>• Check if the CF/SD card access switch is ON.</li> </ul>
7	A file whose size exceeds the file size supported by GOT was attempted to be transferred.	Check if size of transfer file is within 2GB.
10	A GOT folder name is invalid.	Check if unusable characters, such as two-byte characters are used for the GOT folder name.
11	A transfer file name is invalid.	Check if unusable characters, such as two-byte characters are used for transfer file name.
100	Not existing connected FTP server setting ID specified.	<ul style="list-style-type: none"> <li>• Check if there is any error in the connected FTP server setting ID specified in the file transfer setting.</li> <li>• Add the necessary connected FTP server setting.</li> </ul>
200	Access to the storage device failed when the file name or folder name is specified indirectly.	Check whether the setting of device used for indirect specification is correct or not.
507	The number of characters of the folder path and file name exceeds the number of characters of the file which can be handled with the GOT.	Check if the number of characters of the path and file name of the folder does not exceed the followings. <ul style="list-style-type: none"> <li>• FTP server side <ul style="list-style-type: none"> <li>When using GT16: 250 characters</li> <li>For GT15 or GT14: 100 characters</li> </ul> </li> <li>• FTP client side: 78 characters</li> </ul>
600*2	The transfer was skipped since the number of characters of the folder path and file name exceeded the number of characters of the file which can be handled with the GOT. (Only when the file is specified by wild card)	
601*2	The transfer processing is skipped since unusable characters are used for the transfer file name. (Only when the file is specified by wild card)	Check if unusable characters, such as two-byte characters are used for transfer file name.
602*2	The transfer processing is skipped since writing files failed. (Only when the file is specified by wild card)	<ul style="list-style-type: none"> <li>• Transfer the file again since the transfer file might have been in use by another function.</li> <li>• Check if there is available space enough in the writing destination.</li> </ul>
603*2	The transfer processing is skipped since reading files failed. (Only when the file is specified by wild card)	<ul style="list-style-type: none"> <li>• Check whether all files are transferred to send destination folder since the files may be deleted before the file transfer.</li> <li>• Check if the memory card is installed on the GOT.</li> <li>• Check if the CF/SD card access switch is ON.</li> </ul>
606*2	File is not transferred since no files which are specified by the wild card exist. (Only when the file is specified by wild card)	Check whether the specified file name is correct or not.
607*2	A file whose size exceeds the file size supported by GOT was attempted to be transferred. (Only when the file is specified by wild card)	Check if size of transfer file is within 2GB.
610*2	Deleting the source file failed.	Check if the source file is available to delete.

\*1 Status in which the request of the client cannot be received.

\*2 File transfer does not stop since they are warning errors.

## 8.6.2 Troubleshooting

---

The following table details the troubleshooting for the file transfer function (FTP client):

Phenomenon	Definition and Cause	Corrective action
The file cannot be transferred.	Extended functions OS (file transfer function (FTP client)) is not written to GOT.	Write the extended functions OS (file transfer function (FTP client)) to GOT.
	There is some error in the connection setting with the FTP server.	Check the following in the connected FTP server setting. <ul style="list-style-type: none"><li>• FTP server IP address, connection mode, port No.</li><li>• User name and password</li></ul>
	The FTP server is not operating.	Check if the FTP server is not stopped.

### POINT

#### How to check the operating status of the FTP server

1. Connect the personal computer to the hub to which the GOT is connected.
2. Enter the following commands in the command prompt of the personal computer.

```
C:\>ftp  
ftp> open
```

3. Enter the user name and the password following the displayed instructions.

If the login can be complete by the operations above, the FTP server operates and the user name and the password are correct.

If there is no response from the FTP server after the open command is entered, the following causes may be considered.

- The FTP server is stopped.
  - The IP address is invalid.
  - The communication path is not connected.
  - The access is blocked by the firewall.
-

# INDEX

## [A]

- Access range
  - File transfer function (FTP client)..... 7-2
  - FTP server function..... 6-2
  - Mail send function..... 5-3
  - Server and client functions..... 4-10

## [C]

- Connection form ..... 2-2

## [E]

- Error codes and error messages
  - File transfer function (FTP client)..... 8-9
  - FTP server function..... 8-7
  - Mail send function..... 8-6
  - Server and client functions..... 8-4
- Examples of use
  - File transfer function (FTP client)..... 7-14
  - FTP server function..... 6-10
  - Mail send function..... 5-7
  - Server and client functions..... 4-17

## [F]

- Features
  - File transfer function (FTP client)..... 1-8
  - FTP server function..... 1-6
  - Mail send function..... 1-5
  - Server and client functions..... 1-1

## [G]

- Gateway function ..... 1-1
- Gateway information..... 8-2
- General procedure to be followed for using..... 3-1

## [H]

- How to monitor the gateway devices ..... 4-3

## [I]

- Input command at FTP client..... 6-5

## [O]

- Operation on FTP client side ..... 6-5

## [P]

- PLC devices that can be assigned ..... 4-7
- Precautions
  - File transfer function (FTP client)..... 7-16
  - FTP server function..... 6-14
  - Mail send function..... 5-8
  - Server and client functions..... 4-22
  - System configuration ..... 2-6

## [S]

- Settings of file transfer function (FTP client)..... 7-4
  - Destination FTP Server Setting..... 7-5
  - File transfer setting..... 7-7
- Settings of FTP server function ..... 6-4
- Settings of Mail send function..... 5-5
- Settings of Server and client function ..... 4-14
  - Client setting ..... 4-16
  - Server setting ..... 4-14
- Specifications
  - File transfer function (FTP client) ..... 7-1
  - FTP server function..... 6-1
  - Mail send function ..... 5-2
  - Server and client functions..... 4-10
- System configuration of gateway functions ..... 2-1
  - File transfer function (FTP client) ..... 7-3
  - FTP server function..... 6-3
  - Mail send function ..... 5-4
  - Server and client functions..... 4-13

## [T]

- Troubleshooting
  - Common to gateway function..... 8-1
  - File transfer function (FTP client) ..... 8-10
  - FTP server function ..... 8-8
  - Mail send function ..... 8-6
  - Server and client functions..... 8-5
- Types of Controller to GOT connection ..... 2-2

## [W]

- What are the gateway devices..... 4-1

## REVISIONS

\* The manual number is given on the bottom left of the back cover.

Print Date	* Manual Number	Revision
Oct., 2009	SH(NA)-080858ENG-A	First printing : GT Designer3 Version 1.01B
Jan., 2010	SH(NA)-080858ENG-B	GT Designer3 Version 1.10L <ul style="list-style-type: none"> <li>• Compatible with the microcomputer connection (Ethernet)</li> <li>• Extension devices of the OMRON PLC can be set for the gateway devices.</li> <li>• The FXCPU buffer memory can be set for the gateway devices.</li> <li>• Connection with LCPUs supported</li> </ul>
Jun., 2010	SH(NA)-080858ENG-C	GT Designer3 Version 1.17T <ul style="list-style-type: none"> <li>• Devices of the MELSEC-WS and the SICK safety controller can be set for the gateway devices.</li> </ul>
Jan., 2011	SH(NA)-080858ENG-D	GT Designer3 Version 1.23Z <ul style="list-style-type: none"> <li>• Devices of the TOSHIBA PLC (Unified Controller nv series) can be set for the gateway devices.</li> </ul>
Apr., 2011	SH(NA)-080858ENG-E	GT Designer3 Version 1.28E <ul style="list-style-type: none"> <li>• Compatible with the file transfer function (FTP client)</li> </ul>
Jul., 2011	SH(NA)-080858ENG-F	GT Designer3 Version 1.31H <ul style="list-style-type: none"> <li>• Compatible with CC-Link IE Field Network connection</li> </ul>
Oct., 2011	SH(NA)-080858ENG-G	GT Designer3 Version 1.37P <ul style="list-style-type: none"> <li>• The gateway function is compatible with GT14.</li> <li>• The FTP server function is compatible with GT12.</li> <li>• The file transfer function (FTP client) is compatible with receiving files.</li> <li>• Error codes for the file transfer function (FTP client) are added.</li> </ul>
Jan., 2012	SH(NA)-080858ENG-H	Compatible with GT Works3 Version1.40S <ul style="list-style-type: none"> <li>• MELQIC is added to FTP clients which are supported by the FTP server function.</li> <li>• MELQIC is added to FTP servers which are supported by the file transfer function (FTP client).</li> </ul>
Apr., 2012	SH(NA)-080858ENG-I	Compatible with GT Works3 Version1.45X <ul style="list-style-type: none"> <li>• The E drive (USB memory) of the GT16 and GT14 is added to the read drives.</li> <li>• The C Controller module with the FTP server function is added to FTP servers which are supported by the file transfer function (FTP client).</li> </ul>
Sep., 2012	SH(NA)-080858ENG-J	Compatible with GT Works3 Version1.58L <ul style="list-style-type: none"> <li>• The company name of Panasonic Electric Works Co., Ltd. is changed to Panasonic Corporation.</li> <li>• The company name of Yamatake Corporation is changed to Azbil Corporation.</li> <li>• Setting the communication timeout time for the file transfer function (FTP client) by using the GS device supported</li> </ul>
Nov., 2012	SH(NA)-080858ENG-K	SAFETY PRECAUTIONS changed

(Continued to next page)



\* The manual number is given on the bottom left of the back cover.

Print Date	* Manual Number	Revision
Jun., 2013	SH(NA)-080858ENG-L	<p>Compatible with GT Designer3 Version1.74C.</p> <ul style="list-style-type: none"> <li>• The company name of GE Fanuc Automation Corporation is changed to GE Intelligent Platforms.</li> <li>• The company name of Panasonic Corporation is changed to Panasonic Industrial Devices SUNX Co., Ltd.</li> <li>• The company name of Fuji Electric FA Components &amp; Systems Co., Ltd. is changed to FUJI ELECTRIC CO., LTD.</li> <li>• The company name of Fuji Electric Systems Co., Ltd. is changed to FUJI ELECTRIC CO., LTD.</li> <li>• The mail send function is compatible with Outlook2007 and Outlook2010.</li> </ul>
Nov., 2013	SH(NA)-080858ENG-M	<p>Compatible with GT Designer3 Version1.104J</p> <ul style="list-style-type: none"> <li>• MELQIC IU1-1M20-D is added to FTP servers which are supported by the FTP server function.</li> <li>• MELQIC IU1-1M20-D is added to FTP servers which are supported by the file transfer function (FTP client).</li> </ul>
Dec., 2015	SH(NA)-080858ENG-N	<ul style="list-style-type: none"> <li>• Partial corrections</li> </ul>

This manual confers no industrial property rights or any rights of any other kind, nor does it confer any patent licenses. Mitsubishi Electric Corporation cannot be held responsible for any problems involving industrial property rights which may occur as a result of using the contents noted in this manual.

GOT is a registered trademark of Mitsubishi Electric Corporation.

Microsoft, Windows, Windows NT, Windows Server, Windows Vista, and Windows 7 are registered trademarks or trademarks of Microsoft Corporation in the United States and other countries.

Adobe and Adobe Reader are registered trademarks of Adobe Systems Incorporated.

Pentium and Celeron are a registered trademarks of Intel Corporation in the United States and other countries.

Ethernet is a registered trademark of Xerox Corporation in the United States.

MODBUS is a trademark of Schneider Electric SA.

VNC is a registered trademark of RealVNC Ltd. in the United States and other countries.

Other company and product names herein are either trademarks or registered trademarks of their respective owners.



GRAPHIC OPERATION TERMINAL

# GOT1000 Series

Gateway Functions Manual

for GT Works3

MODEL	SW1-GTD3-O(GW)-E
MODEL CODE	1D7MA7
SH(NA)-080858ENG-N(1512)MEE	

## MITSUBISHI ELECTRIC CORPORATION

HEAD OFFICE : TOKYO BUILDING, 2-7-3 MARUNOUCHI, CHIYODA-KU, TOKYO 100-8310, JAPAN  
NAGOYA WORKS : 1-14, YADA-MINAMI 5-CHOME, HIGASHI-KU, NAGOYA, JAPAN

When exported from Japan, this manual does not require application to the Ministry of Economy, Trade and Industry for service transaction permission.

Specifications subject to change without notice.

Printed in Japan, December 2015.